

## Digital Still Camera

# User's Guide/ Troubleshooting

### Operating Instructions

Before operating the unit, please read this manual and "Read This First" (separate volume) thoroughly, and retain them for future reference.

### Owner's Record

The model and serial numbers are located on the bottom. Record the serial number in the space provided below. Refer to these numbers whenever you call upon your Sony dealer regarding this product.

Model No. DSC-R1

Serial No. \_\_\_\_\_

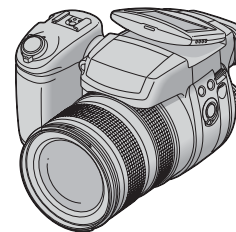

**DSC-R1**

**Cyber-shot**



"Read This First" (separate volume)

Explains the set-up and basic operations for shooting/playback with your camera.



Enjoying the camera



Using the menu



Using the Setup screen



Using your computer



Printing still images



Connecting your camera to your TV



Troubleshooting



Others



Index

Additional information on this product/Image Data Converter SR and answers to frequently asked questions can be found at our Customer Support Website.

<http://www.sony.net/>



Printed on 100% recycled paper using VOC (Volatile Organic Compound)-free vegetable oil based ink.



2654494110

## WARNING

To reduce fire or shock hazard, do not expose the unit to rain or moisture.

## For Customers in the U.S.A. and Canada

### RECYCLING LITHIUM-ION BATTERIES

Lithium-Ion batteries are recyclable.

You can help preserve our environment by returning your used rechargeable batteries to the collection and recycling location nearest you.



For more information regarding recycling of rechargeable batteries, call toll free 1-800-822-8837, or visit <http://www.rbc.org/>

**Caution:** Do not handle damaged or leaking Lithium-Ion batteries.

## For Customers in the U.S.A.

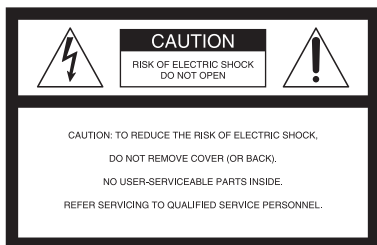

This symbol is intended to alert the user to the presence of uninsulated “dangerous voltage” within the product’s enclosure that may be of sufficient magnitude to constitute a risk of electric shock to persons.



This symbol is intended to alert the user to the presence of important operating and maintenance (servicing) instructions in the literature accompanying the appliance.

If you have any questions about this product, you may call:

Sony Customer Information Services Center  
1-800-222-SONY (7669)

The number below is for the FCC related matters only.

## Regulatory Information

### Declaration of Conformity

Trade Name: SONY  
Model No.: DSC-R1  
Responsible Party: Sony Electronics Inc.  
Address: 16450 W. Bernardo Dr,  
San Diego, CA 92127U.S.A.  
Telephone No.: 858-942-2230

This device complies with Part 15 of the FCC Rules. Operation is subject to the following two conditions: (1) This device may not cause harmful interference, and (2) this device must accept any interference received, including interference that may cause undesired operation.

## CAUTION

You are cautioned that any changes or modifications not expressly approved in this manual could void your authority to operate this equipment.

### Note:

This equipment has been tested and found to comply with the limits for a Class B digital device, pursuant to Part 15 of the FCC Rules.

These limits are designed to provide reasonable protection against harmful interference in a residential installation. This equipment generates, uses, and can radiate radio frequency energy and, if not installed and used in accordance with the instructions, may cause harmful interference to radio communications. However, there is no guarantee that interference will not occur in a particular installation. If this equipment does cause harmful interference to radio or television reception, which can be determined by turning the equipment off and on, the user is encouraged to try to correct the interference by one or more of the following measures:

- Reorient or relocate the receiving antenna.
- Increase the separation between the equipment and receiver.

- Connect the equipment into an outlet on a circuit different from that to which the receiver is connected.
- Consult the dealer or an experienced radio/TV technician for help.

The supplied interface cable must be used with the equipment in order to comply with the limits for a digital device pursuant to Subpart B of Part 15 of FCC Rules.

## For Customers in Europe

This product has been tested and found compliant with the limits set out in the EMC Directive for using connection cables shorter than 3 meters (9.8 feet).

### Attention

The electromagnetic fields at the specific frequencies may influence the picture and sound of this camera.

### Notice

If static electricity or electromagnetism causes data transfer to discontinue midway (fail), restart the application or disconnect and connect the communication cable (USB, etc.) again.

## Disposal of Old Electrical & Electronic Equipment (Applicable in the European Union and other European countries with separate collection systems)



This symbol on the product or on its packaging indicates that this product shall not be treated as household waste. Instead it shall be handed over to the applicable collection point for the recycling of electrical and electronic equipment. By ensuring this product is disposed of correctly, you will help prevent potential negative consequences for the environment and human health, which could otherwise be caused by inappropriate waste handling of this product. The recycling of materials will help to conserve natural resources. For more detailed information about recycling of this product, please contact your local Civic Office, your household waste disposal service or the shop where you purchased the product.

## Notice for customers in the United Kingdom

A moulded plug complying with BS 1363 is fitted to this equipment for your safety and convenience. Should the fuse in the plug supplied need to be replaced, a fuse of the same rating as the supplied one and approved by ASTA or BSI to BS 1362, (i.e., marked with an ⚡ or ⚡ mark) must be used.

If the plug supplied with this equipment has a detachable fuse cover, be sure to attach the fuse cover after you change the fuse. Never use the plug without the fuse cover. If you should lose the fuse cover, please contact your nearest Sony service station.

# Notes on using your camera

## Types of “Memory Stick” that can be used (not supplied)

The IC recording medium used by this camera is a “Memory Stick”. There are two types of “Memory Stick”.

### “Memory Stick”: you can use a “Memory Stick” with your camera.

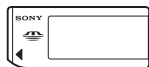

### “Memory Stick Duo”: Inserting a “Memory Stick Duo” into a Memory Stick Duo Adaptor.



Memory Stick Duo Adaptor

- For details on “Memory Stick”, see page 122.

## Notes on the “InfoLITHIUM” battery pack

- Charge the supplied NP-FM50 battery pack before using the camera for the first time. (→ *step 1* in “*Read This First*”)
- The battery pack can be charged even if it is not completely discharged. Also, even if the battery pack is not fully charged, you can use the partially charged capacity of the battery pack as is.
- If you do not intend to use the battery pack for a long time, use up the existing charge and remove it from your camera, then store it in a cool, dry place. This is to maintain the battery pack functions (page 125).
- For details on the usable battery pack, see page 125.

## About the Carl Zeiss lens

This camera is equipped with a Carl Zeiss lens which is capable of reproducing fine images. The lens for this camera uses the MTF<sup>#</sup> measurement system for cameras developed jointly by Carl Zeiss, in Germany, and Sony Corporation, and offers the same quality as other Carl Zeiss lenses. The lens for your camera is also T<sup>\*</sup>-coated to suppress unwanted reflection and faithfully reproduce colors.

<sup>#</sup> MTF is an abbreviation of Modulation Transfer Function, a numeric value indicating the amount of light from a specific part of the subject gathered at the corresponding position in the image.

## Notes on the AC Adaptor

- Do not short the DC plug of the AC Adaptor with a metallic object, as this may cause malfunction.
- Clean the DC plug of the AC Adaptor with a dry cotton swab, etc. Do not use the plug if it is dirty. Use of a dirty plug may not properly charge the battery pack.

## No compensation for contents of the recording

The contents of the recording cannot be compensated for if recording or playback is not possible due to a malfunction of your camera or recording media, etc.

## Back up recommendation

- To avoid the potential risk of data loss, always copy (back up) data to other medium.

## Notes on recording/playback

- This camera is neither dust-proof, nor splash-proof, nor water-proof. Read “Precautions” (page 126) before operating the camera.
- Before you record one-time events, make a trial recording to make sure that the camera is working correctly.
- Be careful not to get the camera wet. Water entering the inside of the camera may cause malfunctions which in some cases may not be repairable.

- Do not aim the camera at the sun or other bright light. It may cause the malfunction of your camera.
- Do not use the camera near a location that generates strong radio waves or emits radiation. The camera may not be able to record or play back properly.
- Using the camera in sandy or dusty locations may cause malfunctions.
- If moisture condensation occurs, remove it before using the camera (page 126).
- Do not shake or strike the camera. In addition to malfunctions and an inability to record images, this may render the recording medium unusable, or cause image data breakdown, damage or loss.
- Clean the flash surface before use. The heat of flash emission may cause dirt on the flash surface to become discolored or to stick to the flash surface, resulting in insufficient light emission.

### Notes on the LCD screen, LCD finder (for models with an LCD finder) and lens

- The LCD screen and the LCD finder are manufactured using extremely high-precision technology so over 99.99% of the pixels are operational for effective use. However, there may be some tiny black points and/or bright points (white, red, blue or green in color) that constantly appear on the LCD screen and the LCD finder. These points are normal in the manufacturing process and do not affect the recording in any way.

#### Black (white/red/blue/green) points

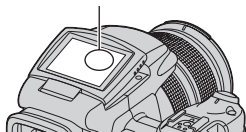

- Exposing the LCD screen, the finder or the lens to direct sunlight for long periods may cause malfunctions. Be careful when placing the camera near a window or outdoors.
- Do not press against the LCD screen. The screen may be discolored and that may cause a malfunction.
- Images may trail across on the LCD screen in a cold location. This is not a malfunction.

- Be careful not to bump the lens, and be careful not to apply force to it.

### On image data compatibility

- This camera conforms with DCF (Design rule for Camera File system) universal standard established by JEITA (Japan Electronics and Information Technology Industries Association).
- Playback of images recorded with your camera on other equipment and playback of images recorded or edited with other equipment on your camera are not guaranteed.

### Warning on copyright

Television programs, films, videotapes, and other materials may be copyrighted. Unauthorized recording of such materials may be contrary to the provisions of the copyright laws.

### The pictures used in this manual

The photographs used as examples of pictures in this manual are reproduced images, and are not actual images shot using this camera.

# For full use of the digital still camera

## Prepare the camera and shoot images easily

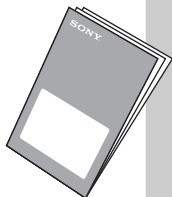

### ***“Read This First” (separate volume)***

- 1 Prepare the battery pack
- 2 Turn the camera on/set the clock
- 3 Insert a recording medium (not supplied)
- 4 Select the image size for use
- 5 Shoot images easily (Auto adjustment mode)
- 6 View/delete images

## Get more friendly with your camera

*This manual*

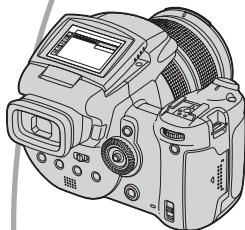

- Shoot with your favorite settings → page 29
- Enjoy various shooting/playback using the menu → page 62
- Change the default settings → page 71

## Connect your camera to a PC or a printer

*This manual*



- Copy your images to a computer and enjoy editing them in various ways → page 83
- Print images by connecting your camera directly to a printer (PictBridge compliant printers only) → page 99

# Table of contents

Notes on using your camera .....	4
----------------------------------	---



## Enjoying the camera

Basic techniques for better images .....	11
Focus – Focusing on a subject successfully .....	11
Exposure – Adjusting the light intensity .....	12
Color – On the effects of lighting .....	13
Quality – On “image quality” and “image size” .....	13

## Before operation















Identifying parts .....	15
Indicators on the screen .....	19
Changing the screen display .....	22
Number of still images .....	23
Battery life and number of images that can be recorded/viewed .....	25

## Advanced shooting

Operation workflow .....	26
Basic operation .....	28
Using the command dial .....	28
Using the mode dial .....	29
Using menu items .....	31
Using the  (Setup) screen .....	32
Matching shooting features to photo-shooting situations .....	33
Exposure setting .....	35
Shooting with Program auto .....	35
Shooting with shutter speed priority mode .....	36
Shooting with aperture priority mode .....	37
Shooting with manual exposure mode .....	39
Selecting the metering mode .....	40
Adjusting the exposure – EV adjustment .....	41
Shooting with the exposure fixed – AE LOCK .....	43
Shooting three images with the exposure shifted – Exposure Bracket .....	44
Selecting the ISO sensitivity – ISO .....	45
Focus setting .....	46
Choosing an auto focus method .....	46
Focusing manually .....	48







Flash .....	50
Selecting a flash mode .....	50
Using the flash manually – Pop-up Flash mode .....	51
Selecting Flash Synchro .....	52
Using an external flash .....	52
Color setting.....	55
Adjusting color tones – White Balance .....	55
Selecting color reproduction .....	57
Shooting continuously.....	58
Burst mode .....	58
Shooting in RAW mode.....	59
RAW mode.....	59
Composing your shot .....	60
Displaying the grid lines .....	60
Monitor mode setting .....	61
Reducing flicker.....	61

## Using the menu

Shooting menu .....	62
 (Image Size)	
 (P.Quality)	
Mode (REC Mode)	
BRK (Bracket Step)	
 (Flash Level)	
PFX (P.Effect)	
COLOR (Color)	
 (Saturation)	
 (Contrast)	
 (Sharpness)	
 (Setup)	
Viewing menu .....	65
 (Folder)	
 (Protect)	
DPOF	
 (Print)	
 (Slide)	
 (Resize)	
 (Rotate)	
 (Setup)	
Trimming	



## Using the Setup screen

 <b>Camera 1</b> .....	71
AF Mode	
Digital Zoom	
Power Save	
Date/Time	
AF Illuminator	
Auto Review	
 <b>Camera 2</b> .....	74
Expanded Focus	
Flash Sync.	
Flash	
Pop-up Flash	
Flicker Reduction	
Grid Line	
 <b>Memory Stick Tool</b> .....	76
Format	
Create REC. Folder	
Change REC. Folder	
 <b>CF Card Tool</b> .....	78
Format	
Create REC. Folder	
Change REC. Folder	
 <b>Setup 1</b> .....	80
LCD Backlight	
EVF Backlight	
Beep	
Zebra	
 Language	
 <b>Setup 2</b> .....	81
File Number	
USB Connect	
Video Out	
Clock Set	

## Using your computer

Enjoying your Windows computer.....	83
Copying images to your computer .....	85
Viewing image files stored on a computer with your camera .....	92
Using the supplied software.....	93
Using your Macintosh computer .....	95

## Printing still images

How to print still images .....	98
Printing images directly using a PictBridge compliant printer .....	99
Printing at a shop.....	103

## Connecting your camera to your TV

Viewing images on a TV screen .....	105
-------------------------------------	-----

## Troubleshooting

Troubleshooting.....	107
Warning indicators and messages.....	118

## Others

On the “Memory Stick” .....	122
On the Microdrive.....	124
On the “InfoLITHIUM” battery pack.....	125
Precautions .....	126
Specifications.....	128
Quick reference chart for shooting.....	130

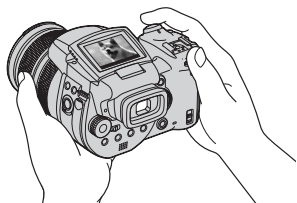

<b>Index</b> .....	132
--------------------	-----

**Focus****Exposure****Color****Quality**

This section describes the basics so you can enjoy your camera. It tells you how to use various camera functions such as the mode dial (page 29), the menus (page 62), and so on.

**Focus** *Focusing on a subject successfully*

When you press the shutter button halfway down, the camera adjusts the focus automatically (Auto Focus). Remember to press the shutter button only halfway down.

Press the shutter button fully down straight away.



Press the shutter button halfway down.

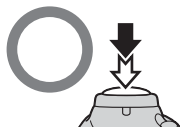

AE/AF lock  
Flashing indicator →  
Indicator lit/beeps



Then press the shutter button fully down.

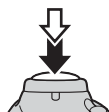

To shoot a still image difficult to focus on → page 48

If the image looks blurred even after focusing, it may be because of camera shake. → See "Hints for preventing blur" (as follows).

**Hints for preventing blur**

Hold the camera steadily, keeping your arms at your side. Also, you can stabilize the camera by leaning against a tree or a building beside you. Using a tripod, and using the flash in dark places are also recommended.



## Exposure Adjusting the light intensity

You can create various images by adjusting the exposure and the ISO sensitivity. Exposure is the amount of light that the camera will receive when you release the shutter.

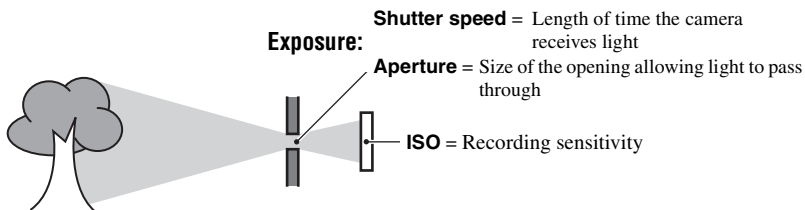

**Overexposure**  
= too much light  
Whitish image

The exposure is automatically set to the proper value in the auto adjustment mode. However, you can adjust it manually using the functions below.



**Correct exposure**

### Manual exposure:

Allows you to adjust the shutter speed and aperture value manually. → page 39



**Underexposure**  
= too little light  
Darker image

### EV:

Allows you to adjust the exposure that has been determined by the camera.  
→ page 41

### Metering Mode:

Allows you to change the part of the subject to be measured to determine the exposure. → page 40

## Adjusting the ISO sensitivity

ISO is unit of measurement (sensitivity), estimating how much light an image pickup device (equivalent to photo films) receives. Even when the exposure is the same, images differ depending on the ISO sensitivity.

To adjust the ISO sensitivity → page 45



### High ISO sensitivity

Records a bright image even when shooting in a dark location. However, the image tends to become noisy.



### Low ISO sensitivity





Records a smoother image.

However, when the exposure is insufficient, the image may become darker.

## Color *On the effects of lighting*

The apparent color of the subject is affected by the lighting conditions.

### Example: The color of an image affected by light sources

Weather/lighting	Daylight	Cloudy	Fluorescent	Incandescent
				
Characteristics of light	White (standard)	Bluish	Blue-tinged	Reddish

The color tones are adjusted automatically in the auto adjustment mode. However, you can adjust color tones manually with white balance (page 55).

## Quality *On "image quality" and "image size"*

A digital image is made up of a collection of small dots called pixels. If it contains a large number of pixels, the picture becomes large, it takes up more memory, and the image is displayed in fine detail. "Image size" is shown by the number of pixels. Although you cannot see the differences on the screen of the camera, the fine detail and data processing time differ when the image is printed or displayed on a computer screen.

Description of the pixels and the image size

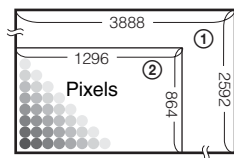

- ① Image size: 10M  
3,888 pixels × 2,592 pixels = 10,077,696 pixels
- ② Image size: 1M  
1,296 pixels × 864 pixels = 1,119,744 pixels

## Selecting the image size for use (→ *step 4 in “Read This First”*)

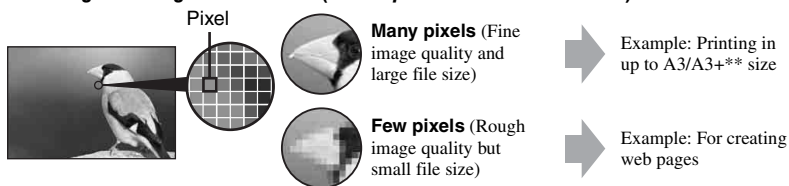

The default settings are marked with ✓.

	Image size*		Usage guidelines
✓	10M (3888×2592)	Larger ↑ ↓ Smaller	For storing important images or printing A3/A3+** size or fine A4 size images.
	7M (3264×2176)		For printing in A4 size or high density images in A5 size
	5M (2784×1856)		
	3M (2160×1440)		
	1M (1296×864)		For printing in postcard size For recording a large number of images For creating web pages

\* The images recorded using the camera are the same 3:2 ratio as used photograph printing paper or postcards, etc.

\*\* This is a size larger than A3 size. You can print images with a margin around the A3 size image.

## Selecting the image quality (compression ratio) in combination (page 62)

You can select the compression ratio when digital images are saved. When you select a high compression ratio, the image lacks the fineness of detail, but has a smaller file size.





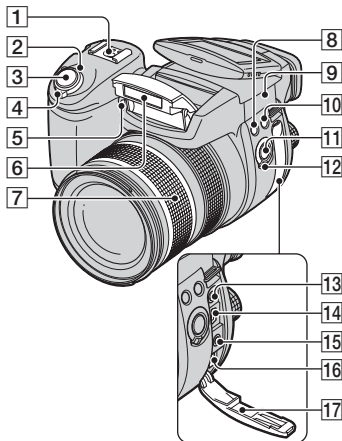

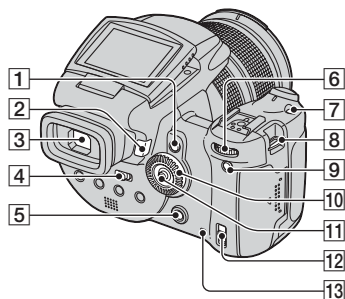

# Identifying parts

See the pages in parentheses for details of operation.







- 1** Advanced accessory shoe (52)
- 2** POWER lamp (→ step 2 in “Read This First”)
- 3** Shutter button (→ step 5 in “Read This First”)
- 4** POWER switch (→ step 2 in “Read This First”)
- 5** Self-timer lamp (→ step 5 in “Read This First”)/AF illuminator (73)
- 6** Flash (→ step 5 in “Read This First”)
- 7** Zoom ring (71, → step 5 in “Read This First”)  
24 28 35 50 70 100 120 Equiv.135  
• Converted to a 35 mm still camera.
- 8** ⚡ (Flash) button (50)
- 9**  $\phi$  Base point of distance mark (→ step 5 in “Read This First”)
- 10** WB (White balance) button (55)
- 11** PUSH AUTO button (48)
- 12** FOCUS switch (48)
- 13** ACC (Accessory) jack (52)
- 14**  $\Psi$  (USB) jack (87)
- 15** VIDEO OUT jack (105)
- 16** DC IN jack
- 17** Jack cover

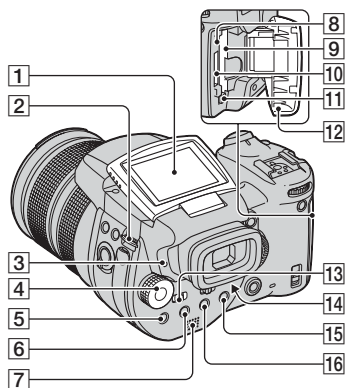



- 1** AE LOCK/  (Delete) button (43, → step 6 in “Read This First”)
- 2**  (Playback) button (→ step 6 in “Read This First”)
- 3** Finder (→ step 5 in “Read This First”)
- 4** FINDER/AUTO/LCD switch (→ step 5 in “Read This First”)
- 5** MENU button (31)
- 6** Main command dial (28)
- 7** ISO button (45)
- 8** Hook for shoulder strap (18)
- 9**  (Screen status) button (22)
- 10** Sub command dial (28)
- 11** Multi-selector (///) (31)
- 12** /CF (“Memory Stick”/CF card) switch (→ step 3 in “Read This First”)
- 13** Access lamp (→ step 3 in “Read This First”)



- 1** LCD screen (22)
- 2** Hook for shoulder strap (18)
- 3**  (Flash charge)/CHG lamp (orange) (→ step 1 in “Read This First”)
- 4** Mode dial (29)
- 5**  (Metering mode) button (40)
- 6**  (Burst)/BRK (Bracket) button (58, 44)
- 7** Speaker
- 8** RESET button (107)
- 9** CF card insertion slot (→ step 3 in “Read This First”)
- 10** “Memory Stick” slot (→ step 3 in “Read This First”)
- 11** CF card eject lever (→ step 3 in “Read This First”)
- 12** “Memory Stick”/CF card cover (→ step 3 in “Read This First”)
- 13** MONITOR switch (61)
- 14** Finder adjustment lever (→ step 5 in “Read This First”)
- 15** For shooting:  (Digital zoom) button (71)  
For viewing:  (Playback zoom) button (→ step 6 in “Read This First”)



- 16**  (Self-timer)/ (Index) button (→ step 5 and step 6 in “Read This First”)

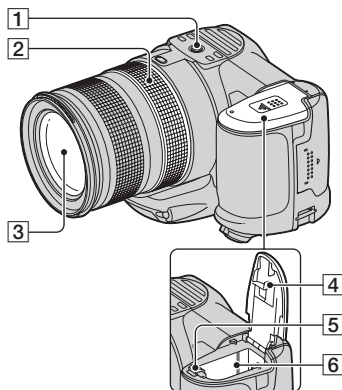

- 1** Tripod receptacle (bottom)
- Use a tripod with a screw length of less than 5.5 mm (7/32 inch). You will be unable to firmly secure the camera to tripods having screws longer than 5.5 mm (7/32 inch), and may damage the camera.
- 2** Manual focus ring (48)
- 3** Lens
- 4** Battery cover (bottom)
- 5** Battery eject lever  
(→ step 1 in “Read This First”)
- 6** Battery insertion slot  
(→ step 1 in “Read This First”)

## Attaching the shoulder strap

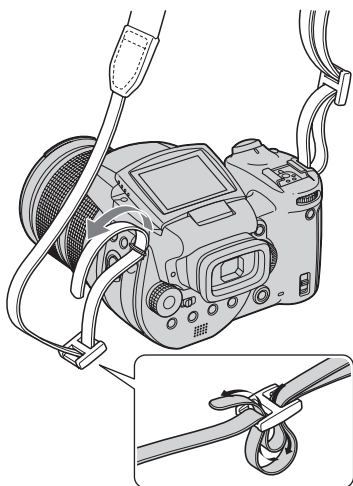

## Attaching the lens hood

When you shoot in bright lighting conditions, such as outdoors, we recommend that you use the lens hood to reduce the image quality deterioration caused by unnecessary light.

Position the lens hood as shown below, by aligning the **U** mark on the lens hood and the **■** mark on the lens, and attach the hood to the lens (①). Turn the lens hood clockwise until it clicks to align with the **●** mark (②).

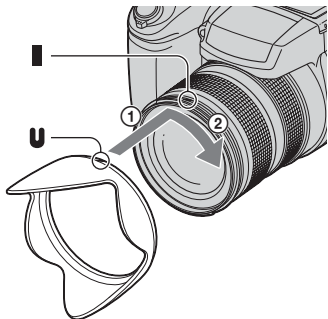

- You can attach the lens cap with the lens hood attached.
- When the lens hood is attached, it may block flashlight or AF illuminator light.

## Storing the lens hood

The lens hood can be attached in the reverse direction to store it with the camera when it is not in use.

Position the lens hood as shown below, by aligning the **●** mark on the lens hood and the **■** mark on the lens, and attach the hood to the lens (①). Turn the lens hood clockwise until it clicks to align with the **●** mark (②).

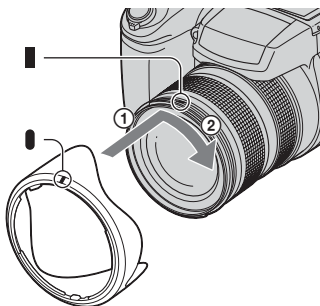

## Attaching a conversion lens (not supplied)

When you want to do enhanced wide-angle shots or zoom-in shots on distant objects, attach a conversion lens.

- ① Attach the lens adaptor (not supplied).
- ② Attach a conversion lens.

- For details, see the operating instructions supplied with your conversion lens.

# Indicators on the screen

See the pages in parentheses for details of operation.

## When shooting still images

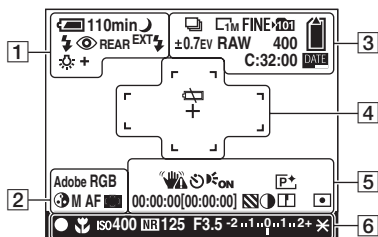

Display	Indication
	Battery remaining (→ <i>step 1</i> in “ <i>Read This First</i> ”)
	Low battery warning (25, 118)
	Mode dial (Scene Selection) (30)
P S A M	Mode dial (29)
	Camera mode (→ <i>step 5</i> in “ <i>Read This First</i> ”)
	Flash mode (50)
	Red-eye reduction (50)
REAR	Flash synchro (52)
EXT	External flash (52)
w  T x1.3  	Zoom scaling (71, → <i>step 5</i> in “ <i>Read This First</i> ”)
	White balance (55)













Display	Indication
Adobe RGB VIVID	Color reproduction (57)

Display	Indication
	Saturation (63)
S AF M AF C AF	AF mode (47)
	AF range finder frame indicator (46)
1.0m	Manual focus distance (48)







Display	Indication
	Burst/Exposure Bracket mode (58, 44)
RAW	RAW mode (59)
	Image size (→ <i>step 4</i> in “ <i>Read This First</i> ”)
FINE STD	Image quality (62)
	Recording folder (76)
	Remaining “Memory Stick” capacity (23)
	Remaining CF card capacity (23)
±0.7EV	Bracket Step value (44)
400	Remaining number of recordable images (23)
C:32:00	Self-diagnosis display (118)
	Date/Time (73)

Display	Indication
	Battery end (25, 118)
+	Spot metering cross hair (40)
	AF range finder frame (46)
[ ]	PUSH AF/Expanded focus frame (48)

5

Display	Indication
	Vibration warning (11) <ul style="list-style-type: none"> <li>Indicates vibration may prevent you from shooting clear images due to insufficient lighting. Even if the vibration warning appears, you can still shoot images. However, we recommend using the flash for better lighting or using a tripod or other means to stabilize the camera.</li> </ul>
	Self-timer (→ step 5 in “Read This First”)
	AF illuminator (73)
 (not displayed on the screen on the previous page)	Histogram (22, 41) <ul style="list-style-type: none"> <li> appears when histogram display is disabled.</li> </ul>
	Picture effect (63)
00:00:00 [00:00:00]	TIME recording (39)
	Zebra (42)
	Contrast (64)
	Sharpness (64)
 	Metering mode (40)
 (not displayed on the screen on the previous page)	Menu/Guide menu (31)

6

Display	Indication
	AE/AF lock (→ step 5 in “Read This First”)
	Macro (→ step 5 in “Read This First”)
ISO400	ISO number (45)
	NR slow shutter (37)
125	Shutter speed (36)
TIME	TIME recording (39)
F3.5	Aperture value (37)
-2..1..0..1..2+	Exposure value bar (41)
-3 . . 0 . . 3+	White balance fine adjustment bar (56)
	AE LOCK (43)
	Manual focus (48)
	Manual focus LOCK (48)

## When playing back still images

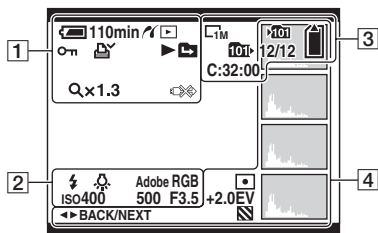
**1**

Display	Indication
	Battery remaining (→ <i>step 1</i> in “Read This First”)
	PictBridge connecting (100)
	Playback mode (→ <i>step 6</i> in “Read This First”)
	Protect (66)
	Print order (DPOF) mark (103)
	Change folder (65)
Qx1.3	Zoom scaling (→ <i>step 6</i> in “Read This First”)
	Do not disconnect the USB cable (101)

**2**

Display	Indication
	Flash
	White balance (55)
Adobe RGB VIVID	Color reproduction (57)
iso400	ISO number (45)
500	Shutter speed (36)
F3.5	Aperture value (37)
101-0012	Folder-file number (65)

**3**

Display	Indication
	Image size (→ <i>step 4</i> in “Read This First”)
	Recording folder (76)
	Playback folder (65)
	Remaining “Memory Stick” capacity (23)
	Remaining CF card capacity (23)
8/8 12/12	Image number/Number of images recorded in selected folder
C:32:00	Self-diagnosis display (118)

**4**

Display	Indication
	Metering mode (40)
+2.0EV	Exposure Value (39, 41)
	Zebra
	Histogram (22, 41) •  appears when histogram display is disabled.
2005 1 1 9:30 AM	Recorded date/time of the playback image (73)
	Menu/Guide menu (31)
(not displayed on the screen on the left column)	
◀ BACK/ NEXT	Select images

# Changing the screen display

Each time you press the  (Screen status) button, the display changes as follows.

## During shooting

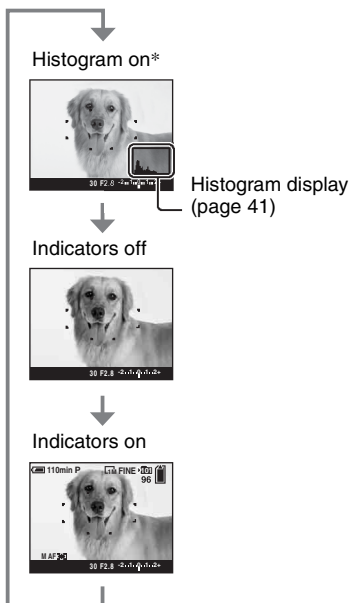

\* When [Zebra] is set to [On], diagonal stripes are also displayed to check high brightness level portions (page 42).

• The histogram does not appear in the following situations:

While shooting

- The menu is displayed.
- You are shooting in the digital zoom range

During playback

- The menu is displayed.
- In index mode
- You are using playback zoom.
- You are rotating still images.

• A large difference in the histogram/zebra displayed when shooting (an image displayed before pressing the shutter button) and during

playback (an image displayed after pressing the shutter button) may occur when:

- The flash strobes.
  - The shutter speed is slow or high.
- The histogram may not appear for images recorded using other cameras.

## During playback

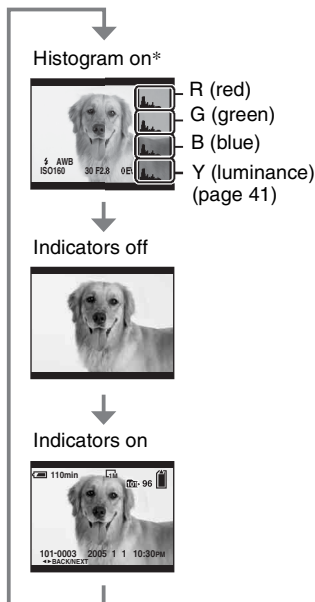

# Number of still images

The tables show the approximate number of still images that can be recorded on a recording medium formatted with this camera. The values may vary depending on the shooting conditions.

**The number of still images (The image quality is [Fine] on the upper line and [Standard] on the lower line.)**

## “Memory Stick” (Normal mode)

(Units: Images)

Size \ Capacity	32MB	64MB	128MB	256MB	512MB	1GB	2GB	4GB
10M	6	12	25	46	94	192	394	779
	12	25	51	92	188	384	789	1559
7M	8	16	32	59	121	247	506	1000
	15	30	60	109	223	456	934	1847
5M	12	24	49	89	181	370	759	1500
	24	49	98	178	363	741	1519	3001
3M	20	41	82	148	302	617	1266	2501
	40	82	164	297	605	1235	2532	5003
1M	57	115	232	420	854	1743	3574	7063
	122	246	493	892	1815	3705	7596	15009

## “Memory Stick” (RAW mode)

(Units: Images)

Size \ Capacity	32MB	64MB	128MB	256MB	512MB	1GB	2GB	4GB
10M	1	2	4	8	18	37	76	150
	1	2	5	9	20	41	84	167
7M	1	2	5	9	19	38	79	157
	1	2	5	10	20	41	85	169
5M	1	2	5	9	20	41	84	166
	1	2	5	10	21	43	89	176
3M	1	2	5	10	21	42	88	174
	1	2	5	10	21	44	91	180
1M	1	2	5	10	22	44	92	182
	1	3	6	10	22	45	93	184

**Microdrive (Normal mode)**

(Units: Images)

Size \ Capacity	1GB	2GB	4GB	6GB
10M	213	405	811	1217
	426	811	1622	2434
7M	273	520	1041	1562
	505	961	1922	2883
5M	410	780	1561	2343
	821	1561	3123	4686
3M	684	1301	2603	3905
	1369	2603	5206	7810
1M	1933	3675	7349	11026
	4108	7809	15618	23431

**Microdrive (RAW mode)**

(Units: Images)

Size \ Capacity	1GB	2GB	4GB	6GB
10M	41	78	156	235
	45	86	173	260
7M	43	81	163	245
	46	88	176	265
5M	45	86	173	259
	48	91	183	274
3M	47	90	181	271
	49	93	187	281
1M	49	94	189	284
	50	96	192	288

- RAW mode → page 59
- When the number of remaining shootable images is greater than 9,999, the “>9999” indicator appears.
- You can resize the images later ([Resize], page 68).
- When images recorded using earlier Sony models are played back on this camera, the display may differ from the actual image size.



# Battery life and number of images that can be recorded/viewed

The tables show the approximate number of images that can be recorded/viewed and the battery life when you shoot images in [Normal] mode with the battery pack (supplied) at full capacity and at an ambient temperature of 25°C (77°F). The numbers of images that can be recorded or viewed take into account changing the recording medium as necessary.

Note that the actual numbers may be less than those indicated depending on the conditions of use.

- The battery capacity decreases as the number of uses increases and also over time (page 125).
- The number of images that can be recorded/viewed and the battery life are decreased under the following conditions:
  - The surrounding temperature is low.
  - The flash is used frequently.
  - The camera has been turned on and off many times.
  - The zoom is used frequently.
  - [LCD Backlight] or [EVF Backlight] is set to [Bright].
  - [AF Mode] is set to [Continuous].
  - The battery power is low.
- When using a CF card, the battery life and the number of images recordable or viewable may differ.

## When shooting still images

Recording medium	LCD/ Finder	No. of images	Battery life (min.)
"Memory Stick"	LCD	Approx. 500	Approx. 250
	Finder	Approx. 520	Approx. 260
Microdrive	LCD	Approx. 460	Approx. 230
	Finder	Approx. 480	Approx. 240

- Shooting in the following situations:
  -  (P.Quality) is set to [Fine].
  - [AF Mode] is set to [Monitor].
  - Shooting once every 30 seconds.

- The zoom is switched alternately between the W and T ends.
- The flash strobes once every two times.
- The power turns on and off once every ten times.
- The measurement method is based on the CIPA standard.  
(CIPA: Camera & Imaging Products Association)
- The number of shooting images/battery life does not change, regardless of image size.

## When viewing still images

Recording medium	No. of images	Battery life (min.)
"Memory Stick"	Approx. 11000	Approx. 550
Microdrive	Approx. 6600	Approx. 330

- Viewing single images in order at about three second intervals

# Operation workflow

The following chart shows the workflow for the operations - preparation, shooting, and playback. If you do not know when or how to operate a function or what you are to do, operate the camera based on the workflow. For shooting, this workflow is designed with various functions set.

## Preparation



- Prepare the battery pack (→ *step 1 in "Read This First"*)
- Prepare the recording medium (→ *step 3 in "Read This First"*)
- Basic settings
  - Power Save (page 72)
  - Date/Time (page 73)
  - LCD Backlight (page 80)
  - EVF Backlight (page 80)
  - Beep (page 80)
- Matching shooting features to photo-shooting situations (page 33)

## Confirmation before shooting



- Select your shot using the either finder or the LCD screen (→ *step 5 in "Read This First"*)
- Monitor mode (FRAMING/PREVIEW) (page 61)
- Select the recording medium ("Memory Stick"/CF card) (→ *step 3 in "Read This First"*)
- Select the image size for use (→ *step 4 in "Read This First"*)
- Flicker reduction (page 61)

## Setup for shooting



- Rec Mode (page 59)
- Focus (AF Mode/AF range finder frame) (page 46)
- Metering mode (page 40)
- White Balance (page 55)
- Burst/Exposure Bracket (pages 58, 44)
- Flash mode (page 50)

## Correction right before shooting



- Zoom (page 71)
- White balance fine adjustment (page 56)
- EV adjustment (page 41)
- Flash level (page 63)
- Focus (page 48)
- Focus frame position (page 48)

## Setting right before shooting



- Last confirmation of the image (Histogram/Displayed information) (page 41)
- Self-timer (→ *step 5 in “Read This First”*)
- AE LOCK (page 43)

## Shooting



- Press the shutter button halfway down/press the shutter button fully down (→ *step 5 in “Read This First”*)

## Confirmation of image shot









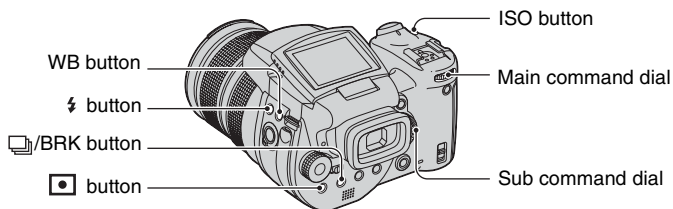





- Auto review (page 73)
- Playback (→ *step 6 in “Read This First”*)
- Playback zoom (→ *step 6 in “Read This First”*)
- Index-screen (→ *step 6 in “Read This First”*)
- Delete (→ *step 6 in “Read This First”*)

# Basic operation

## Using the command dial

Used for setting a value or selecting options.



Main command dial	
<p>Decrease a value/Move the cursor to the left</p> 	<p>Increase a value/Move the cursor to the right</p> 
<p>Program Shift (P mode) (page 35) Shutter speed (S mode) (page 36) Aperture (A mode) (page 37) Shutter speed (M mode) (page 39)</p>	
<p>Displays a previous/next image → <i>step 6 in “Read This First”</i></p>	
In combination with other buttons	
	 Flash mode (page 50)
	 White Balance mode (page 55)
	 Metering mode (page 40)
	 Burst/Exposure Bracket mode (pages 58, 44)
	 ISO (page 45)
Sub command dial	
 <p>Decrease a value/Display the previous index screen</p>	<p>Increase a value/Display the next index screen</p>
<p>Exposure (P/S/A/  /  /  /  mode) (page 41) Aperture (M mode) (page 39)</p>	
<p>Displays the previous/next index screen → <i>step 6 in “Read This First”</i> Activates/cancels playback zoom → <i>step 6 in “Read This First”</i> Changes the zoom scaling → <i>step 6 in “Read This First”</i></p>	
In combination with other button	
 	<p>White balance fine adjustment (page 56)</p>

## Using the mode dial

Set the mode dial to the desired function.

Using an outline icon, the available modes for setting the function, menu, or Setup are indicated at the right side on each title bar in the manual.

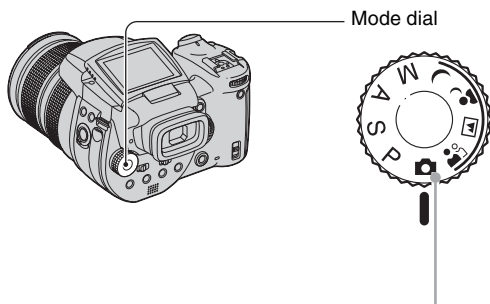

### Still image shooting modes

#### : **Auto adjustment mode**

Allows easy shooting with the settings adjusted automatically. → *step 5 in “Read This First”*

#### : **Scene Selection mode**

Allows you to shoot with preset settings according to the scene. (page 30)

#### **P:** **Program auto shooting mode**

Allows you to shoot with the exposure adjusted automatically (both the shutter speed and the aperture value).

#### **S:** **Shutter speed priority shooting mode**

Allows you to shoot after adjusting the shutter speed manually (page 36).

#### **A:** **Aperture priority shooting mode**

Allows you to shoot after adjusting the aperture value manually (page 37).

#### **M:** **Manual exposure shooting mode**

Allows you to shoot after adjusting the exposure manually (both the shutter speed and the aperture value) (page 39).

## Scene Selection

- ① Set the mode dial to the following positions.
- ② Shoot the image.



 **Portrait**  
Shoots with backgrounds blur away, and the subject is sharpened.



 **Landscape**  
Shoots landscapes, etc., by focusing on a distant subject.













 **Twilight portrait\***  
Shoots portraits in dark places.





 **Twilight\***  
Shoots night scenes at a distance without losing the dark atmosphere of the surroundings.

For shooting an image appropriately according to the scene condition, a combination of functions is determined by the camera.

(✓: you can select the desired setting)

	Macro	Flash	White Balance	Burst/ Exposure Bracket
	✓	✓	✓**	✓
	—	⚡ /  / 	✓**	✓
	✓	⚡SL / 	AWB /  WB / 	—
	—		✓	—

\* The shutter speed becomes slower, so using a tripod is recommended.

\*\* When the flash mode is ⚡ (Forced flash) or  (Forced flash with red-eye reduction), the setting is canceled and it is set to auto (except when WB (Flash) or  (One push) is selected).

## Using menu items

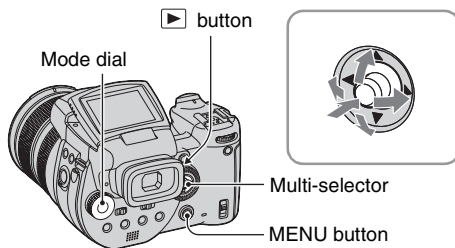

**1** Turn on the power.

**2** Menu for shooting: Set the mode dial.  
Menu for playback: Press the **▶** button.

Different items are available depending on the position of the mode dial or the shooting/playback mode.

**3** Press MENU to display the menu.

**4** Select the desired menu item by moving the multi-selector to **◀/▶**.

- If the desired item is invisible, keep the multi-selector by moving to **◀/▶** until the item appears on the screen.
- Press the center of the multi-selector after selecting an item in playback mode.

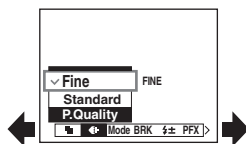

**5** Select the setting by moving the multi-selector to **▲/▼**.

The setting you select is zoomed and is set.

**6** Press MENU to turn off the menu.

### To turn to the shooting mode

Press and hold the shutter button half way down so that the menu disappears.

- You cannot select items that are grayed out.

## Using the (Setup) screen

You can change the default settings using the  (Setup) screen.

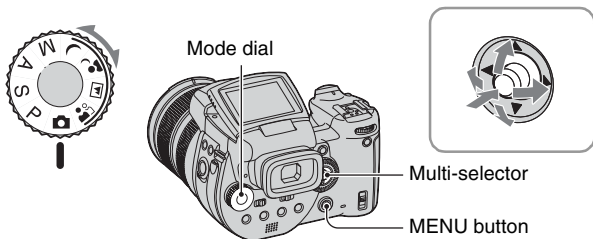

**1** Turn on the power.

**2** Press MENU to display the menu.

**3** Move the multi-selector to **▶** to select  (Setup), then move the multi-selector to **▶**.

**4** Move the multi-selector to **▲/▼/◀/▶** to select the item you want to set.

The frame of the selected item turns yellow.

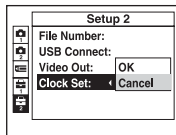

**5** Press the center of the multi-selector to enter the setting.

To turn off the  (Setup) screen, press MENU.

To return to the menu from the  (Setup) screen, move the multi-selector to **◀** repeatedly.

 When the menu is not displayed

Pressing down MENU for about 1.5 seconds turns the  (Setup) screen on.

### To cancel the (Setup) setting

Select [Cancel] if it appears, then press the center of the multi-selector. If it does not appear, select the previous setting again.

• This setting is maintained even when the power is turned off.



# Matching shooting features to photo-shooting situations

After you are familiar with your camera, let's shoot an image in various situations with some settings changed. This section describes some representative shooting examples.

## Q: To shoot a portrait with its background blurred



### ➔ Shooting with aperture priority mode (page 37)

When you want to enhance the person with the background blurred, adjust the aperture manually. The more the aperture is opened (the aperture value becomes smaller), the narrower the focus is. The background is blurred accordingly.

## Q: To shoot a portrait against light



### ➔ Selecting a flash mode (page 50)

Shooting a human subject in a bright place can create dim facial shadows. This occurs when the background is brighter than the person. In such cases, set the flash to  $\text{⚡}$  (Forced flash). You can shoot both the person and the background clearly.

- You can use the flash within the reach of the flash light.

## Q: To shoot a night scene



### ➔ Shooting with shutter speed priority mode (page 36)

Using the flash in the auto adjustment mode restricts the shutter speed and the flash light does not reach distant subjects. The image, therefore, is not captured clearly. In such cases, slow the shutter speed manually, set the flash to  $\text{⊕}$  (No flash), and reduce the light using the EV adjustment. You can then shoot a clear night scene.

## Q: To shoot without flash



### ➔ Selecting the ISO sensitivity (page 45)

When you cannot use the flash or set the shutter speed slower, increase the ISO rating. The higher rated ISO setting helps maximize the effect of the surrounding light to shoot.

We recommend that you set the ISO sensitivity according to the shutter speed so that the vibration warning indicator (page 120) is not displayed.

## Q: To shoot a moving subject



### → Shooting with shutter speed priority mode (page 36)

When shooting a moving person or subject, set the shutter speed higher to freeze the motion or set the shutter speed slower to get the flow of motion of the subject. Adjust the shutter speed to express a moment that is beyond the speed of the naked eye.

## Q: To shoot the beautiful afterglow of the sunset



### → Adjusting color tones (page 55)

If the image you shot is not expressed in your favorite colors, change the white balance mode. Setting the white balance mode to  (Daylight) enhances the redness of the sunset.

# Exposure setting

## Shooting with Program auto



In program auto mode, the camera automatically adjusts the shutter speed and the aperture according to the brightness of the subject just as in the auto adjustment mode (mode dial: ). In addition, the program auto mode can change the shooting settings in the menu, a feature which the auto adjustment mode does not have (page 130).

### Program Shift

You can change the aperture value and shutter speed combination while keeping the brightness fixed.

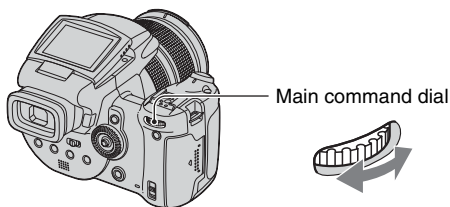

- ① Select the aperture value and shutter speed combination using the main command dial. P\* is indicated while the aperture value and shutter speed combination is shifted.
- ② Shoot the image.

To cancel Program Shift, turn the main command dial to return the indication from P\* to P.

- You cannot shift the aperture value and shutter speed combination when the shutter button is pressed halfway down.
- When the brightness changes, the aperture value and shutter speed also change while maintaining the shift amount.
- You may not be able to change the aperture value and shutter speed combination depending on your shooting situations.
- When the flash mode setting is changed, Program Shift is canceled.
- Setting the mode dial to other than P or turning off the power cancels Program Shift.



You can adjust the shutter speed manually. If you shoot a moving subject at a higher shutter speed, it appears as if frozen on the image. At a lower shutter speed, the subject appears as if it is flowing.

Aperture value is automatically adjusted to attain correct exposure according to the brightness of the subject.



High shutter speed



Slow shutter speed

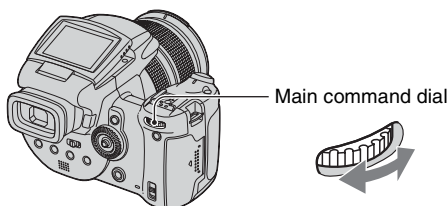

- ① Select a shutter speed using the main command dial.

You can select following shutter speeds.

When ISO is [160] to [800]: 1/2000 to 30 seconds

When ISO is [1600] to [3200]: 1/2000 to 8 seconds

- ② Shoot the image.

- Shutter speeds of one second or longer are indicated by ['], for example, 1".
- When you set the shutter speed slower, using a tripod is recommended to prevent the effects of vibration.
- If the proper exposure is not obtained after making the settings, the setting value indicators on the screen flash when the shutter button is pressed halfway down. You can shoot in this condition, but we recommend that you adjust the flashing values again.
- The flash is set to (Forced flash), (Forced flash with red-eye reduction) or (No flash).
- When the shutter speed is high, the amount of flash light may be insufficient even if you fire the flash.

### 💡 NR slow shutter

The NR slow shutter mode reduces noise from recorded images, providing clear images. When using certain shutter speeds\*, the camera automatically works the NR slow shutter mode and “NR” is indicated next to the shutter speed indicator.



Press the shutter button fully down.

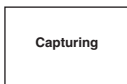

Then the screen turns black.



Finally, when “Processing” disappears, the image has been recorded.

\* When ISO is [160] to [400]: 1/6 second or slower

When ISO is [800] to [3200]: 1/25 second or slower

- To eliminate the effects of vibration, use of a tripod is recommended.
- When a slow shutter speed is set, the processing may take some time. This is because the camera works to remove noise during the time set by the shutter speed setting.

### 💡 Shooting techniques



When shooting a moving person, car, or spindrift, etc., using the high shutter speed, you can express moment that is beyond what the human eye can see.



When shooting a subject such as the flow of a river at a slower shutter speed, you can create an image that captures the subject’s flowing movement. In such cases, use of a tripod is recommended to prevent camera shake.

- When you hand-hold the camera, we recommend that you adjust the shutter speed in a range where  (Vibration warning indicator) is not indicated.

## Shooting with aperture priority mode



You can adjust the amount of light that passes through the lens. If you open the aperture (a smaller F-number), the amount of light allowed into the lens increases and the in-focus range becomes narrower. Only the main subject is then in focus. When the aperture is closed (a larger F-number), the amount of light decreases and the in-focus range becomes wider. The whole image is sharpened.

The shutter speed is automatically adjusted to obtain correct exposure according to the brightness of the subject.



Open the aperture



Close the aperture

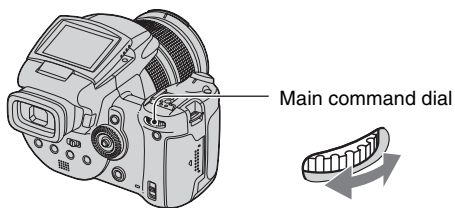

- ① Select an aperture value using the main command dial.
  - When the zoom is set fully to the W side, you can select an aperture from F2.8 to F16.
  - When the zoom is set fully to the T side, you can select an aperture from F4.8 to F16.

② Shoot the image.

- The shutter speed is automatically adjusted from 1/2000 to 8 seconds.
- If the proper exposure is not obtained after making the settings, the setting value indicators on the screen flash when the shutter button is pressed halfway down. You can shoot in this condition, but we recommend that you adjust the flashing values again.
- The flash is set to (Forced flash), (Forced flash with red-eye reduction), (Slow synchro), (Slow synchro with red-eye reduction) or (No flash).

Shooting techniques

The depth of field is the in-focus range. Opening the aperture makes the depth of field shallower (the in-focus range becomes narrower) and closing the aperture makes the depth of field wider (the in-focus range becomes wider).

**Open the aperture**

The subject is clear and its background is blurred.



**Close the aperture**

Both the subject and its background are focused on.

Adjust the aperture to suit your purpose, either to sharpen the specific area of image, or to focus on the entire image.

You can manually adjust the shutter speed and aperture values.

The camera maintains the setting even when the power is turned off. Once you set a value you like, you can reproduce the same exposure by simply setting the mode dial to M.

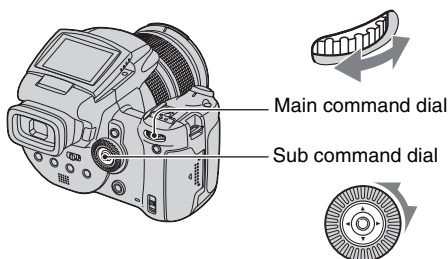

① Select a shutter speed using the main command dial.

② Select an aperture value using the sub command dial.

The difference between the settings and proper exposure judged by the camera appears on the EV bar (page 41) on the screen. 0EV indicates the value judged as the most suitable by the camera.

100 F3.5 -2..1..0..1..2+

Underexposure

50 F3.5 -2..1..0..1..2+

Correct exposure

40 F3.5 -2..1..0..1..2+

Overexposure

③ Shoot the image.

- If the proper exposure is not obtained after making the settings, the setting value indicators on the screen flash when the shutter button is pressed halfway down. You can shoot in this condition, but we recommend that you adjust the flashing values again.
- The flash is set to (Forced flash), (Forced flash with red-eye reduction) or (No flash).

#### On TIME shooting

You can expose for a desired time. For example, when shooting fireworks, press the shutter button to start exposing at the moment the fireworks are set off and release the shutter at the moment the fireworks explode.

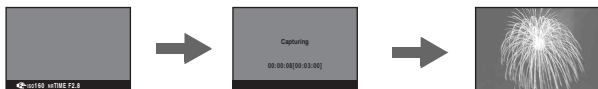

① Select [TIME] from the shutter speed options. This is indicated next to [30"].

② Press the shutter button so that the camera starts exposing, and press the shutter button again so that the camera finishes exposing.

- ISO is set to [160].
- For TIME shooting, the maximum time available is up to three minutes. After three minutes, the shutter will be automatically released (when the battery is low level, the shutter is released after about 30 seconds).
- We recommend that you use a tripod (not supplied).

## Selecting the metering mode



Selects the metering mode that sets which part of the subject to measure to determine the exposure.

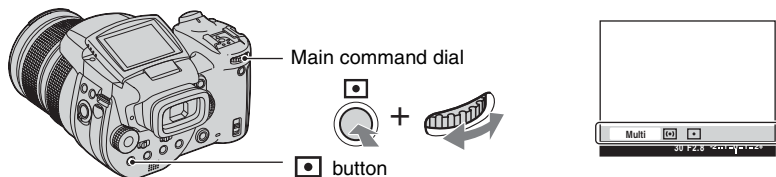

Press and hold (Metering mode) and turn the main command dial to select the desired setting.

(: The default setting)

	Multi (Multi-pattern metering)	Divides into multiple regions and measures each region. The camera determines a well-balanced exposure.
	(Center-weighted metering)	Measures the center of the image, and determines the exposure based on the brightness of the subject there.
	(Spot metering)	Measures only a part of the subject.  <p>Spot metering cross hairs Positions on the subject.</p> <ul style="list-style-type: none"> <li>• This function is useful when the subject is backlit or when there is strong contrast between the subject and the background.</li> </ul>

- For details on the exposure → page 12
- When using (Spot metering) or (Center-weighted metering), setting the AF range finder frame to (Center AF) is recommended to focus on the metering position (page 46).



## Adjusting the exposure – EV adjustment



You can manually shift the exposure value determined by the camera. Use this mode when you do not get the proper exposure, for instance, the subject and its background have high contrast (light and dark).

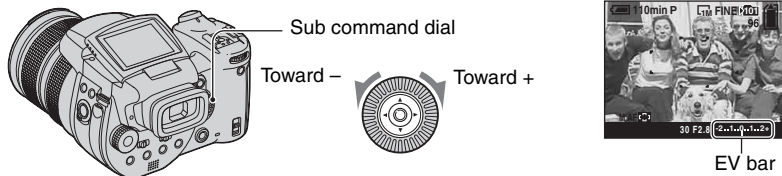

Turn the sub command dial to select an EV adjustment value.

Toward +: Brightens an image.

0EV: The exposure is determined automatically by the camera.

Toward -: Darkens an image.



- For details on the exposure → page 12
- The compensation value can be set in 1/3EV increments.
- If a subject is being shot in extremely bright or dark conditions, or the flash is used, the exposure adjustment may not be effective.

### Adjusting EV (Exposure Value) by checking the screen (Histogram/Zebra pattern)

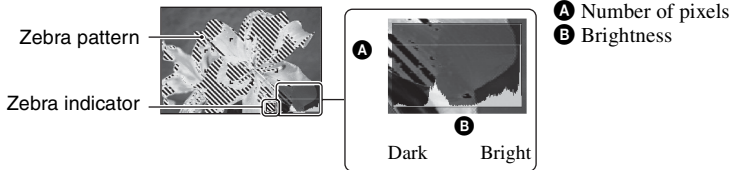

## Histogram

A histogram is a graph showing the brightness of an image. Press [ ] (Screen status) repeatedly to display the histogram inside the screen. The graph display indicates a bright image when skewed to the right side, and a dark image when skewed to the left side. Adjust EV while checking the exposure with the histogram.

- The histogram also appears in the following cases, but you cannot adjust the exposure.
  - When the mode dial is set to or M
  - When playing back a single image

## Zebra pattern

When [Zebra] is set to [On] in the  (Setup) menu (page 80), and the histogram is displayed, the zebra pattern (diagonal stripes) is displayed on high brightness level portions (where luminance exceeds a certain level and loses the tone). Adjust the exposure checking the portions indicated by the zebra pattern.

- The zebra pattern is not recorded on an image.

### Shooting techniques

While shooting images, the camera automatically determines the exposure. When shooting a whitish overall image such as a backlit subject or a snowy scene, the camera judges that the subject is bright and may set a darker exposure for the image. In such cases, adjustment of the exposure in the + plus direction is effective.



Adjust in the + direction



When shooting a darker overall image, the camera judges that the subject is dark and may set a brighter exposure for the image. In such cases, adjustment of the exposure in the - minus direction is effective.



Adjust in the - direction



You can check the exposure referring to the histogram chart. Be careful not to overexpose or underexpose your subject (giving a whitish or darkish image).

You can try to adjust the exposure to suit your taste.

You can lock the exposure before recomposing the image. This is useful when the contrast of the subject and its background is extremely high or you shoot a backlit subject.

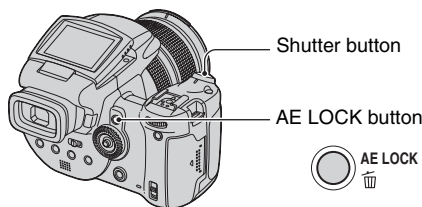

- 1 Target the subject for which you want to meter the exposure, then press AE LOCK. The exposure is fixed and the **\*** indicator appears.

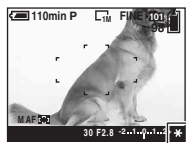

- 2 Recompose the image and press and hold the shutter button halfway down. The focus is automatically adjusted.
- 3 Press the shutter button fully down.
  - AE LOCK is canceled if you release the shutter button or have shot an image. When you want to retain the exposure for the next shot, press and hold the AE LOCK button, then shoot the next image.

#### Shooting techniques

The camera automatically adjusts the exposure according to the subject. If you change the composition of your shot, the exposure may be changed, such as by changes in the brightness of the background. In such cases, use the AE lock function. You can shoot freely, regardless of the brightness of the subject.

- 1 To determine the exposure, measure the exposure of the desired portion of the subject using either center-weighted metering or the spot metering function.
- 2 Press AE LOCK to lock the exposure, and then recompose the picture and shoot.

Portion of the image used to determine the exposure



## Shooting three images with the exposure shifted – Exposure Bracket



In addition to an image with the exposure automatically set by the camera, two other images are recorded with exposure values shifted to the + and – sides.

If you cannot shoot with the proper brightness due to the brightness of the subject, use the Exposure Bracket mode. You can select the image that has a suitable exposure after shooting.



+ direction

Correct

– direction

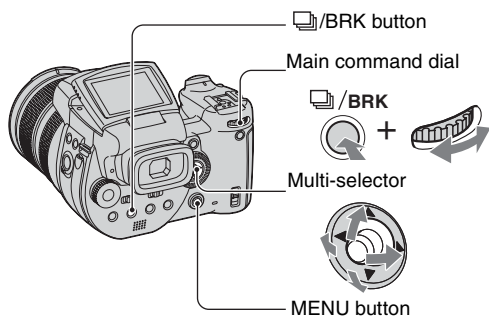

- ① Press and hold /BRK (Bracket) and turn the main command dial to select [BRK].
- ② Press MENU.
- ③ Select [BRK] (Bracket Step) by moving the multi-selector to ◀▶, then select the desired bracket step value by moving to ▲▼.

(✔: The default setting)

	±1.0EV	Shifts the exposure value by plus or minus 1.0EV.
✔	±0.7EV	Shifts the exposure value by plus or minus 0.7EV.
	±0.3EV	Shifts the exposure value by plus or minus 0.3EV.

- The flash is set to (No flash).
- The focus and white balance are adjusted for the first image, and these settings are also used for the other images.
- When the exposure is manually adjusted (page 41), the exposure is shifted based on the adjusted brightness.
- The recording interval is approximately 0.32 second.
- If the subject is too bright or too dark, you may be unable to shoot properly with the selected bracket step value.

- The shutter speed is limited as follows
  - When ISO is [160] to [400]: 1/2000 – 1/8 second
  - When ISO is [800] to [3200]: 1/2000 – 1/30 second

## Selecting the ISO sensitivity – ISO



Selects a luminous sensitivity with units of ISO. The larger the number, the higher the sensitivity.

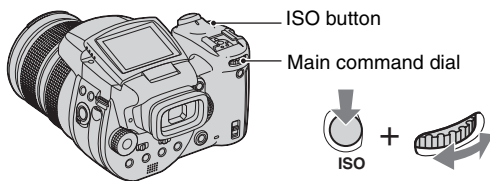

Press and hold ISO and turn the main command dial to select the desired setting.

(✓: The default setting)

3200	Select a large number when shooting in dark locations or shooting a subject moving at high speed, or select a small number to obtain high image quality.
1600	
800	
400	
200	
160	
✓ Auto	Automatically adjusts the ISO sensitivity.

- For details on the ISO sensitivity → page 12
- Note that the image tends to become noisier as the ISO sensitivity number increases.
- ISO is set to [Auto] in the Scene mode.

# Focus setting

## Choosing an auto focus method



You can set the AF range finder frame and the AF mode.



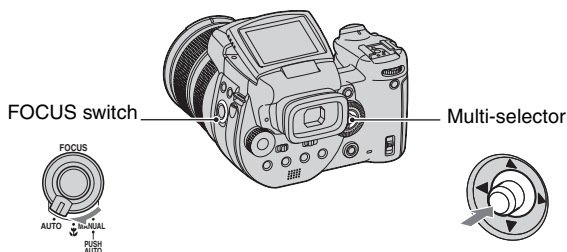

### Choosing a focus range finder frame – AF range finder

You can change the focus method. Use the menu when it is difficult to get the proper focus in auto focus mode.





- ① Set the FOCUS switch to AUTO.
- ② Press the center of the multi-selector repeatedly to select the desired mode.

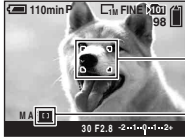



(✔: The default setting)

✔	 (Multipoint AF)	<p>Focuses automatically on a subject in all ranges of the finder frame. When the mode dial is set to , Multipoint AF is automatically selected.</p> <ul style="list-style-type: none"> <li>• This mode is useful when the subject is not in the center of the frame.</li> </ul>  <p>AF range finder frame AF range finder frame indicator</p>
	 (Center AF)	<p>Focuses automatically on a subject in the center of the finder frame.</p> <ul style="list-style-type: none"> <li>• Using this with the AF lock function lets you shoot in the desired image composition.</li> </ul>  <p>AF range finder frame AF range finder frame indicator</p>

 (Flexible Spot AF)	<p>Focuses on an extremely small subject or a narrow area. Flexible Spot AF lets you shoot in the desired image composition.</p> <ul style="list-style-type: none"> <li>• This is useful when you shoot using a tripod and the subject is out of the center area.</li> </ul>
--	--

- AF stands for Auto Focus.
- When you use digital zoom or AF Illuminator, priority AF movement is given to subjects in or near the center of the frame. In this case, the ,  or  indicator flashes and the AF range finder frame is not displayed.

## To set the Flexible Spot AF

- ① Press the center of the multi-selector repeatedly to select  (Flexible Spot AF).
- ② Move the AF range finder frame to the portion you want to focus on by moving the multi-selector to ///.

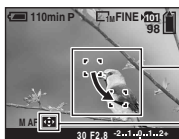

— AF range finder frame

— AF range finder frame indicator





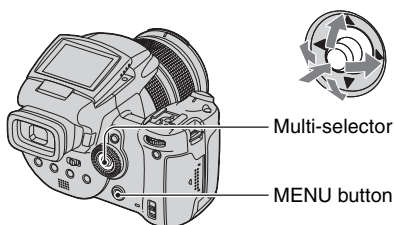

When you press and hold the shutter button halfway down, and the focus is adjusted, the color of the AF range finder frame changes from white to green.

- When shooting a moving subject, take care to hold the camera steady so that the subject does not deviate from the range finder frame.

## Choosing a focus operation – AF Mode

Selects the auto focus operation mode.



- ① Display the  (Setup) screen (page 32).
- ② Select  (Camera 1) by moving the multi-selector to , then select [AF Mode] by moving to /.
- ③ Select the desired mode by moving to /, then press the center of the multi-selector.

(✔: The default setting)

	Single (S AF)	Automatically adjusts the focus when the shutter button is pressed and held halfway down. This mode is useful for shooting stationary subjects.
✔	Monitor (M AF)	Automatically adjusts the focus before the shutter button is pressed and held halfway down. This mode shortens the time needed for focusing. <ul style="list-style-type: none"><li>• Battery consumption may be faster than in [Single] mode.</li></ul>
	Continuous (C AF)	Adjusts the focus before you press and hold the shutter button halfway down, and then continues to adjust the focus even after AF lock is completed. This mode allows shooting of moving subjects with continued focus. <ul style="list-style-type: none"><li>• Battery consumption may be faster than in any other AF mode.</li></ul>

On the [Continuous (C AF)]

- Focus adjustment may not be able to keep up when shooting fast moving subjects.
- The AF range finder frame is Center AF (page 46).
- The focus is not adjusted after the lock is completed in the following cases, and the “C AF” indicator flashes. The camera operates in [Monitor] mode.
  - When shooting in the dark place
  - When shooting with a slow shutter speed
- There is no lock sound when the focus is achieved.
- When you press the shutter button all the way down using the self-timer, the focus is locked.

## Focusing manually



When shooting a subject through a net or through window glass, it is difficult to get the proper focus in auto focus mode. In these cases, manually adjusting the focus is convenient.

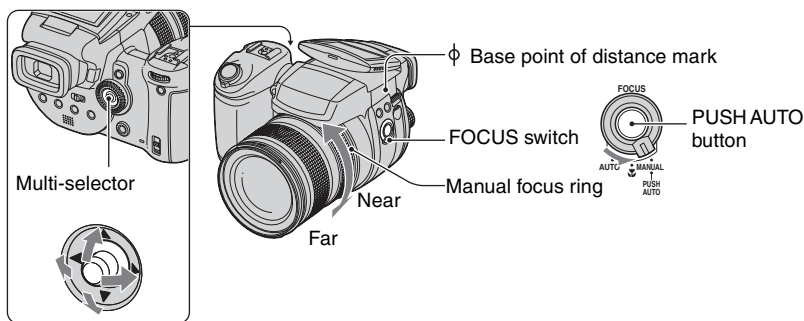







① Set the FOCUS switch to MANUAL.



The  (manual focus) indicator and PUSH AF/Expanded focus frame appear on the screen.



 PUSH AF/Expanded focus frame

The distance from the  $\phi$  base point of distance mark  
 T side: About 40 cm (15 3/4 inches) –  $\infty$   
 W side: About 35 cm (13 7/8 inches) –  $\infty$

② Move the PUSH AF/Expanded focus frame to the portion you want to focus on by moving the multi-selector to ///.



Using the expanded focus function (page 74), the area around the PUSH AF/Expanded focus frame is doubled ( turns yellow), so you can easily focus on a subject. When you stop rotating the manual focus ring, the expanded display will be canceled after about two seconds ( turns white).

③ Turn the manual focus ring to achieve a sharp focus.

When the  indicator flashes, the focus distance has reached its limit.

- Manual focus distance information is approximate.
- The PUSH AF/Expanded focus frame is not displayed when using the digital zoom.
- To cancel the expanded focus function → page 74

 Convenient focus adjustment function

Pressing the PUSH AUTO button focuses on a subject located near the PUSH AF/Expanded focus frame ( turns to ). Since this helps to achieve the focus easily, you can use this function as a preparation before doing fine adjustment with manual focus ring.



Manual focus Lock indicator

Flashing indicator → Indicator lit (for about five seconds)

# Flash

## Selecting a flash mode



Normally, the flash automatically strobes when the surroundings are dark. You can intentionally change the flash mode.

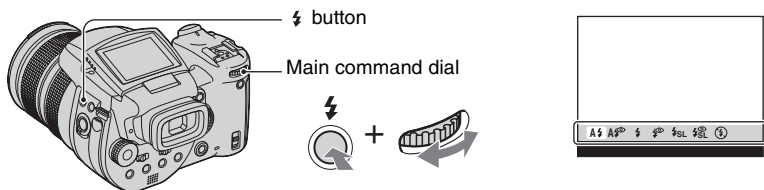

Press and hold **⚡** (Flash) and turn the main command dial to select the desired mode.

(✓: The default setting)

✓	<b>A</b> ⚡ (Auto)	Strobes if it is dark or against light. • In Program auto mode, the flash does not strobe even if the subject is against light.
	<b>A</b> ⚡ <sup>RED</sup> (Auto with red-eye reduction)	Reduces red-eye in Auto mode.
	<b>⚡</b> (Forced flash)	The flash strobos regardless of the amount of ambient light.
	<b>⚡</b> <sup>RED</sup> (Forced flash with red-eye reduction)	Reduces red-eye in Forced flash mode.
	<b>⚡</b> SL (Slow synchro)	The shutter speed is slow in a dark place to clearly shoot the background that is out of flash light.
	<b>⚡</b> SL <sup>RED</sup> (Slow synchro with red-eye reduction)	Reduces red-eye in Slow synchro mode.
	<b>ⓧ</b> (No flash)	The flash does not strobos.

- Note that the surface of the flash emitter may be hot right after you use the flash several times in succession.
- The recommended distance from the  $\phi$  base point of distance mark using the flash is about 0.5 m to 8.5 m (1 feet 7 3/4 inches to 27 feet 10 3/4 inches) (W)/0.4 m to 5.0 m (1 feet 3 3/4 inches to 16 feet 4 7/8 inches) (T) (when ISO is set to [Auto]).
- Attaching the supplied lens hood or the optional lens adaptor blocks a flash light.
- Because the shutter speed is slower under dark conditions when **⚡**SL (Slow synchro), **⚡**SL<sup>RED</sup> (Slow synchro with red-eye reduction) or **ⓧ** (No flash) is selected, it is recommended that you use a tripod.
- While the flash is being charged, the **⚡**/CHG lamp flashes. After charging is completed, the lamp goes out.
- You can change the brightness of the flash using [Flash Level] in the menu settings (page 63).
- In dark surroundings, fill light is emitted to focus on a subject. When you do not use that light, set [AF Illuminator] to [Off] (page 73).
- You can mount an external flash on this camera (page 52).

On the [Red-eye reduction]



Reduces the red-eye phenomenon when using the flash. The  (Red-eye reduction) indicator appears on the screen.

- The flash pre-strobes twice or more before shooting.
- Because it takes about a second until the shutter clicks, hold the camera firmly to prevent the effects of vibration. Also, do not let the subject move.
- Red-eye reduction may not produce the desired effects depending on individual differences, the distance to the subject, if the subject does not see the pre-strobe, or other conditions.



### Using the flash manually – Pop-up Flash mode

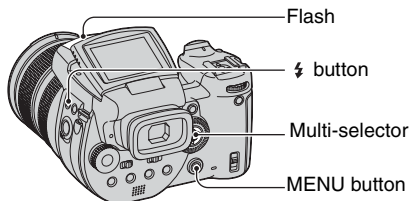

You can strobes the flash only when you want to use it. Set [Pop-up Flash] to [Manual] in the  (Setup) menu (page 74).





- ① Press  (Flash) and pop up the flash.
- ② Select the flash mode (page 50).
- ③ Shoot the image.

- The flash does not strobe in  (Twilight) mode in the Scene mode or in Burst/Bracket mode.
- Close the flash when you do not want to use the flash.
- To set the pop-up flash to auto mode, set [Pop-up Flash] to [Auto] in the  (Setup) menu.



### Shooting techniques

Making the best of the flash gives you various options.





When you set the flash mode to  (Forced flash) or  (Forced flash with red-eye reduction), you can shoot a backlit subject brightly. An effect in which the flash light reflects in the subject's eye is also available.



When the flash mode is set to  (Auto) or  (Auto with red-eye reduction), the flash may strobe regardless of your intentions. In such situations, setting the flash mode to  (No flash) slows the shutter speed automatically. This is effective when you shoot the trail of a car, the spectrum of a light, or the sunset. We recommend you use a tripod to prevent camera shake.



The  (Slow synchro) or  (Slow synchro with red-eye reduction) is effective when you shoot a person during a sunset and the like. You can shoot the person clearly using the flash light and the background using a long exposure. If the camera cannot shoot clearly using the slow shutter, it automatically increases the ISO number. We recommend you use a tripod to prevent camera shake.

## Selecting Flash Synchro



Select the timing that the flash strobes.



Front



Rear

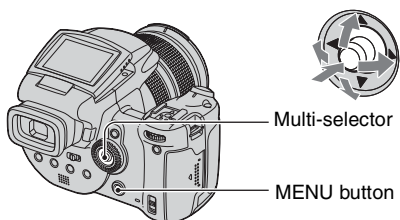

Multi-selector

MENU button

- ① Display the (Setup) screen (page 32).
- ② Select (Camera 2) by moving the multi-selector to , then select [Flash Sync.] by moving to .
- ③ Select the desired mode by moving to , then press the center of the multi-selector. (✓: The default setting)

✓	Front	Normally, use this setting. Since the flash strobes right after the shutter is released, this allows you to get your shot closer to the time you release the shutter.
	Rear (REAR)	Used for a moving subject, etc. Since the flash strobes right before the shutter is closed, this allows you to reflect the trail of a light or movement afterimage on a subject.

On the [Rear]

- When the shutter speed is too high, the [Rear] setting effect may not be available.
- When the red-eye reduction is selected, the red-eye reduction effect may not be available at slower shutter speeds.

## Using an external flash



You can mount an optional external flash. Using an external flash increases the amount of light and that will allow you to shoot more vivid flash pictures than when using the internal flash.

For details, refer to the operating instructions supplied with your flash.

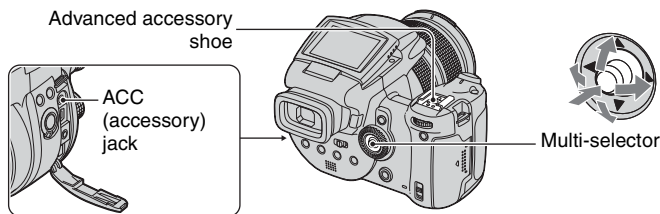

- When an external flash is mounted, the weight prevents the lens portion from becoming steady. We recommend supporting the lens portion with your left hand or using a tripod for recording.
- You cannot have an external flash and the built-in flash strobe at the same time.
- If you shoot with two or more external flashes connected to the advanced accessory shoe, note that the camera may not be able to function properly, or that may cause a malfunction.
- When the proper white balance is not set using an external flash, set the flash mode to  $\text{⚡}$  (Forced flash),  $\text{⚡}$  (Forced flash with red-eye reduction),  $\text{⚡SL}$  (Slow synchro) or  $\text{⚡SL}$  (Slow synchro with red-eye reduction), then set the white balance using the  $\text{●SET}$  (One push SET) (page 55).

## Using the Sony Flash

You can mount the following Sony flashes on the advanced accessory shoe of your camera.









- HVL-F1000
- HVL-F32X (equipped with automatic flash level adjustment and AF fill light shooting functions)



- ① Mount the external flash on the advanced accessory shoe.
- ② Plug the flash into the ACC (accessory) jack.  
When using the HVL-F32X, skip Step ②.
- ③ Turn on the external flash.
- ④ Shoot the image.

- Check that [Flash] is set to [Int.] in the  $\text{⚙}$  (Setup) menu (page 74).
- When ISO is set to [800], [1600] or [3200], you cannot use the AUTO “B” mode of the HVL-F32X.
- When using the “B” mode of the HVL-F1000/F32X, the flash level (page 63) is set to the following two options.  
When [Flash Level] is between +0.3EV and +2.0EV: Strong  
When [Flash Level] is between -0.3EV and -2.0EV: Weak
- When using the flash in a wider angle than a focal length of 35 mm, peripheral area may be darkened. We recommend that you use a wide panel.

## Using a commercially available external flash

You can mount a commercially available external flash that supports the advanced accessory shoe.

- ① Mount the external flash to the advanced accessory shoe.
- ② Display the  (Setup) screen (page 32).
- ③ Select  (Camera 2) by moving the multi-selector to /, [Flash] by moving to /, [Ext.] by moving to /, then press the center of the multi-selector.
- ④ Turn on the external flash.
- ⑤ Set the mode dial to M or A.  
The flash also strobes when the mode dial is not set to M or A but we recommend recording with the mode dial set to M or A.
- ⑥ Shoot the image.

- If you record with [Flash] set to [Int.] in the  (Setup) menu, the built-in flash may pop up. If this happens, return the built-in flash to its original position and set [Flash] to [Ext.] (page 74).
- When you set [Flash] to [Ext.] in the  (Setup) menu, **EXT** is indicated. In this case, the built-in flash is disabled.
- Set the most appropriate aperture value according to the guide number of the flash used and the distance to the subject.
- The flash guide number varies according to the ISO sensitivity (page 45) of the camera, so be sure to check the ISO number.
- Note that the camera may not function properly or may malfunction when using a flash manufactured by another company for a specific camera (generally a flash with multiple contact points on the advanced accessory shoe), a high-voltage type flash, or a flash accessory.
- Depending on the type of commercially available external flash, you may be unable to use some functions, and other operations may be difficult.

# Color setting

## Adjusting color tones – White Balance



Normally, the camera automatically adjusts the color tones. However, you can also adjust them according to the lighting conditions.

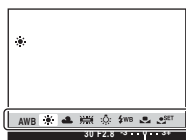
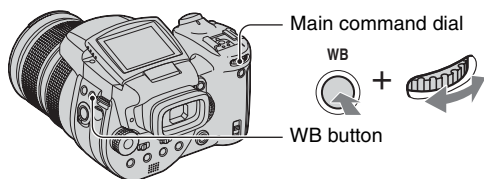









Press and hold WB (White balance) and turn the main command dial to select the desired setting.

(✓: The default setting)

✓	AWB (Auto)	Adjusts the White Balance automatically. (Color temperature: about 3400-7000 K)
☀	(Daylight)	Adjusts for outdoors, shooting night scenes, neon signs, fireworks, or sunrise, or conditions before and after sundown. (Color temperature: about 5500 K)
☁	(Cloudy)	Adjusts for a cloudy sky. (Color temperature: about 6500 K)
💡	(Fluorescent)	Adjusts for fluorescent lighting. (Color temperature: about 4000 K)
💡	(Incandescent)	Adjusts for places where the lighting conditions change quickly such as at a party hall, or under bright lighting such as at photography studios. (Color temperature: about 3200 K)
⚡	(Flash)	Adjusts for the flash conditions. (Color temperature: about 6000 K)
📧	(One push)	Adjusts the white balance depending on the light source. The white color memorized in 📧 <sup>SET</sup> (One push SET) mode becomes the basic white color. Use this mode when AWB (Auto) or other modes cannot set the color properly. (Color temperature: about 2000 – 10000 K)
📧 <sup>SET</sup>	(One push SET)	Memorizes the basic white color which will be used in 📧 (One push) mode.

- For details on the white balance → page 13
- Under fluorescent lights that flicker, the white balance function may not work correctly even though you select [💡] (Fluorescent).
- Except in [⚡] (Flash) or [📧] (One push) mode, white balance is set to AWB (Auto) when the flash strobes.
- Some options are not available depending on the flash mode (page 50).
- Some options are not available depending on the Scene mode (page 30).



## To capture the basic white color in SET (One push SET) mode

- 1 Press and hold WB (White balance) and turn the main command dial to select [  SET ] (One push SET).
  - 2 Frame a white object such as a piece of paper filling the screen under the same lighting conditions as you will shoot the subject.
  - 3 Press the center of the multi-selector.  
The screen momentarily turns black and the  SET indicator flashes quickly. When the white balance has been adjusted and stored in the memory,  (One push) is selected.
- If the  indicator flashes slowly, the white balance has not been set or cannot be set. Use automatic white balance.
  - Do not shake or strike the camera while the  SET indicator flashes quickly.
  - When flash mode is set to  (Forced flash),  (Forced flash with red-eye reduction)  SL (Slow synchro) or  SL (Slow synchro with red-eye reduction) the white balance is adjusted to the condition with the flash emitting.

## To make fine adjustments

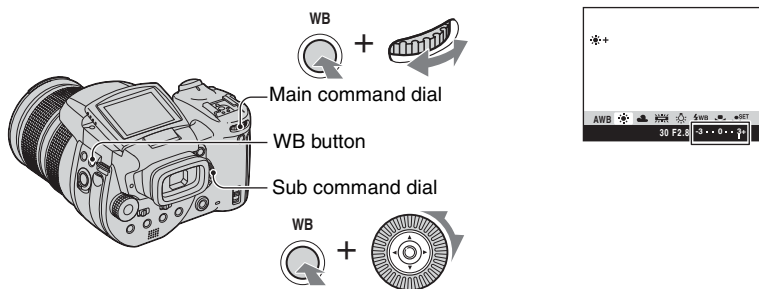
Using this adjustment, you can shoot with a color conversion filter effect. The adjustment can be set in  $\pm 3$  steps and its compensation is equivalent to 10 mired for each step (see below). This adjustment is available except for AWB (Auto).



- 1 Press and hold WB (White balance) and turn the main command dial to select a mode closer to the lighting conditions.
  - 2 Press and hold WB (White balance) and turn the sub command dial to set the fine adjustment value. + or - is indicated next to the selected mode icon.
- Depending on the type of fluorescent light, fine adjustment may not be achieved properly even if you select  (Fluorescent).
  - When you use the flash except in  WB (Flash) or  (One push) mode, you cannot make the fine adjustment, since the white balance is set to Auto.

### On mired

Mired is a measurement unit that multiplies the inverse number of a color temperature by  $10^6$ . As for the color temperature, regardless of its variation width, the lower the color temperature is, the larger its temperature difference is, and vice versa. Mired expresses the variation width in the approximate proportion and it is used as a measurement for units of color conversion filters.



Variation width 1000 K: Difference of mired (M)  
 4000-3000 K: 83 M  
 7000-6000 K: 23 M

## Selecting color reproduction



Selects the color reproduction mode.

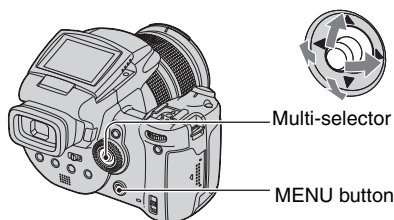

- ① Press MENU.
- ② Select COLOR (Color) by moving the multi-selector to ◀▶, then select the desired mode by moving to ▲▼.

(✔: The default setting)

✔	Adobe RGB ( <b>Adobe RGB</b> )	This mode has a wide range of color reproduction for faithfulness to the actual texture and color. <ul style="list-style-type: none"> <li>• The file name of the image recorded in Adobe RGB mode is “_DSC□□□□.JPG”. (When in RAW mode, its file extension is “.SR2”.)</li> </ul>
	Vivid ( <b>VIVID</b> )	Imposing scenery is expressed by deep and vivid color, such as blue sky, sunset, new green leaves, and colorful autumn leaves.
✔	Standard	Various scenes are expressed by tone-rich and beautiful color.

### ✔ On Adobe RGB

This format has a wide range of color space and is suitable for printing.

- When you display images recorded in Adobe RGB mode on TVs/LCD monitors that are not compatible with Adobe RGB (DCF2.0/Exif2.21), the images are displayed at a lower intensity level. Also, using incompatible printers, the images may be printed out at a lower intensity level.
- When you record images in Adobe RGB mode, the images are displayed on the LCD/finder of the camera at a lower intensity level. Using printers that are compatible with Adobe RGB (DCF2.0/Exif2.21), you can print them out with faithfulness to the actual texture and color.
- For [Standard] and [Vivid], images are recorded in the sRGB (color space) format adopted by ordinary PC monitors.

# Shooting continuously

## Burst mode



Records the maximum three images in succession when you press and hold down the shutter button.

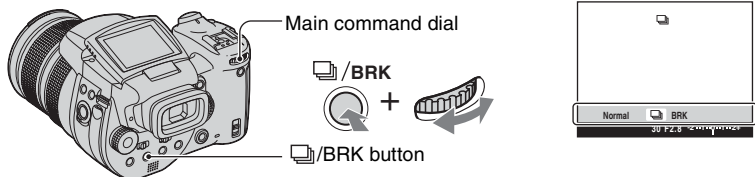

Press and hold /BRK (Bracket) and turn the main command dial to select [].

- When “Recording” disappears, you can shoot the next image. However, if you press the shutter button while the access lamp is lit, the maximum number of images is two.
- The flash is set to (No flash).
- The recording interval is approximately 0.32 second.
- The shutter speed is limited as follows.  
When ISO is [160] to [400]: 1/2000 – 1/8 second  
When ISO is [800] to [3200]: 1/2000 – 1/30 second
- When the battery level is low, or when the recording medium is full, the Burst stops.

# Shooting in RAW mode

## RAW mode



The camera records the data captured from the CMOS sensor directly without compression. The file extension is “.SR2” (page 90). After copying the images to your computer, the data can be reproduced with much less deterioration in image processing and be displayed using the exclusive software provided. A compressed JPEG format image like the one recorded in normal shooting is recorded at the same time.

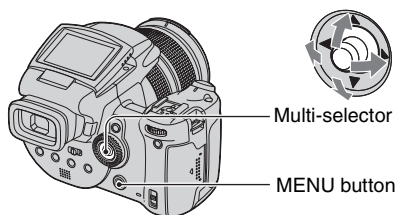

- ① Press MENU.
  - ② Select [Mode] (REC Mode) by moving the multi-selector to ◀/▶, then select [RAW] by moving to ▲/▼.
- To reproduce the RAW data file using a computer, the exclusive software is required. Install the exclusive software on the supplied CD-ROM (Image Data Converter SR Ver.1.0) (Windows/Macintosh) to your computer. Since the RAW data file is a special kind of file, general software cannot open the RAW data file (pages 94, 97).
  - The JPEG image is also recorded in the image size selected by the Image Size setup (→ *step 4* in “*Read This First*”). Since RAW data images are recorded in [10M] size, these data consume larger capacity of a recording medium.
  - Writing data takes more time than in normal recording mode.
  - Digital zoom cannot be used.
  - In playback mode, the JPEG image recorded at the same time is displayed, and menu operations, such as image rotation, trimming, are done to only the JPEG image. The RAW data files cannot be played back or modified using the camera.

# Composing your shot

## Displaying the grid lines



With reference to the grid lines, you can easily set a subject in a horizontal/vertical position.

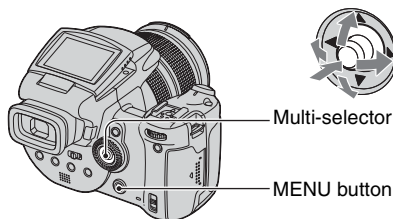

- 1 Display the (Setup) screen (page 32).
- 2 Select (Camera 2) by moving the multi-selector to , [Grid Line] by moving to .
- 3 Select [On] by moving to , then press the center of the multi-selector. (✔: The default setting)

	On	Displays the grid lines.
✔	Off	Does not display the grid lines.

- The grid lines are not recorded.

### Shooting techniques

- When composing your shot, trying to use “three-way split” is effective. Display the grid lines to divide the screen into three parts each by height and width, and position the subject at one of the points at the intersection of the horizontal grid line with vertical one. In that way, you can get a stable and well-balanced composition. Also, positioning two subjects at two intersection points diagonally is effective.

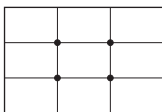

# Monitor mode setting

## Reducing flicker



When you shoot under fluorescent light, flicker may occur on the screen depending on regions. You can reduce that flicker.

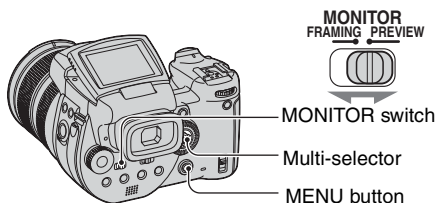

Set the MONITOR switch to the desired mode.

FRAMING	Reduces the flicker. To confirm the subject, the screen is brighter while monitoring (Auto Bright Monitoring).
PREVIEW	Does not reduce the flicker. Before shooting, you can confirm the depth of field (page 38). Starting time and shutter lag time are shorter than that of [FRAMING] mode.

### When the flicker is not reduced in [FRAMING] mode

Normally, the camera automatically detects the flickering cycle and reduces the flicker. However, if it is not detected properly, set the power supply frequency (50Hz/60Hz) of your region beforehand. The flicker will be reduced.

- ① Display the (Setup) screen (page 32).
- ② Select (Camera 2) by moving the multi-selector to , [Flicker Reduction] by moving to .
- ③ Select the desired mode by moving to , then press the center of the multi-selector.

(: The default setting)

	60Hz	For regions where the power supply frequency is 60 Hz.
	50Hz	For regions where the power supply frequency is 50 Hz.
	Auto	The camera automatically detects the power supply frequency: 50 Hz or 60 Hz.



# Shooting menu

The default settings are marked with ✓.

## (Image Size) P S A M

✓	10M (3888×2592)	For details, see page 14.
	7M (3264×2176)	
	5M (2784×1856)	
	3M (2160×1440)	
	1M (1296×864)	

## (P. Quality) P S A M

Selects the still image quality.

✓	Fine (FINE)	Records with high quality (low compression).
	Standard (STD)	Records with standard quality (high compression).

• For details on the image quality → page 13

## Mode (REC Mode) P S A M

	RAW	Records RAW data file in addition to the JPEG file.
✓	Normal	Records with normal shooting.

• For details, see page 59.

## BRK (Bracket Step) P S A M

Records a series of three images with the exposure values automatically shifted.

	±1.0EV	For details, see page 44.
✓	±0.7EV	
	±0.3EV	

## ± (Flash Level)



Adjusts the amount of flash light.

	↑ +2.0EV	Toward +: Makes the flash level higher.
✓	0EV	The amount of flash light that the camera adjusts automatically.
	↓ -2.0EV	Toward -: Makes the flash level lower.

- The flash level can be set in 1/3 EV increments.
- The value is not displayed on the screen. It is indicated as + or –.
- To change flash mode → page 50
- If the subject is too bright or dark, this adjustment may have no effect.
- When the flash mode is set to (🚫) (No flash), you cannot adjust the flash level.

## PFX (P.Effect)



Allows you to shoot an image with special effects.

	B & W (P <sup>+</sup> )	Records the image in monochrome (black and white).
	Sepia (P <sup>+</sup> )	Records the image in sepia (like an old photograph).
✓	Off	No effect.

- This setting is not maintained when the power is turned off.

## COLOR (Color)



Selects the color reproduction mode.

	Adobe RGB (Adobe RGB)	For details, see page 57.
	Vivid (VIVID)	
✓	Standard	

## ⊕ (Saturation)





Adjusts the saturation of the image.

	+ (⊕)	Toward +: Brightens the color.
✓	Normal	
	- (⊖)	Toward -: Darkens the color.

 (Contrast)

Adjusts the contrast of the image.

	+ (☉)	Toward +: Enhances the contrast.
✓	Normal	
	- (☉)	Toward -: Reduces the contrast.
	A.G.C.S. (Advanced Gradation Control System) (☉)	<p>When the subject is darkened by a backlight so that the subject has no tone, or the subject is in uniform tone, such as sky and clouds, this mode increases or decreases the LD ratio according to the scene to express a wide range of tone.</p> <ul style="list-style-type: none"> <li>• When the flash strobos, the A.G.C.S. function does not work. If you shoot a subject beyond reach of the flash light using the A.G.C.S. function, set the flash to  (No flash).</li> </ul> <div style="text-align: center;">  </div>

 (Sharpness)

Adjusts the sharpness of the image.

	+ (▣)	Toward +: Sharpens the image.
✓	Normal	
	- (▣)	Toward -: Softens the image.

 (Setup)

See pages 32, 71.



The default settings are marked with ✓.

## Folder

Selects the folder containing the image you want to play back when using the camera with recording medium.

	OK	See the following procedure.
✓	Cancel	Cancels the selection.

- ① Select the desired folder by moving the multi-selector to ◀/▶.

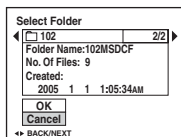

- ② Select [OK] by moving to ▲, then press the center of the multi-selector.

### 💡 On the folder

The camera stores images in a specified folder of a recording medium (pages 76, 78). You can change the folder or create a new one.

- To create a new folder → [Create REC. Folder] (pages 76, 78)
- To change the folder for recording images → [Change REC. Folder] (pages 77, 79)
- When multiple folders are created in the recording medium and the first or last image in the folder is displayed, the following indicators appear.

◀: Moves to the previous folder.

▶: Moves to the next folder.

◀▶: Moves to either the previous and next folders.

**Protect**

Protects images against accidental erasure.

✓	Protect (Protect)	See the following procedure.
	Exit	Exits the Protection function.

**To protect images in single-image mode**

- ① Display the image you want to protect.
- ② Press MENU to display the menu.
- ③ Select [Protect] by moving the multi-selector to ◀▶, then press the center of the multi-selector.  
The image is protected and the Protect indicator appears on the image.



- ④ To protect other images, select the desired image by moving to ◀▶, then press the center of the multi-selector.

**To protect images in index mode**

- ① Press [Index] (Index) to display the index screen.
- ② Press MENU to display the menu.
- ③ Select [Protect] by moving the multi-selector to ◀▶, then press the center of the multi-selector.
- ④ Select [Select] by moving to ▲▼, then press the center of the multi-selector.
- ⑤ Select the image you want to protect by moving to ▲▼/◀▶, then press the center of the multi-selector.  
A green Protect indicator appears on the selected image.

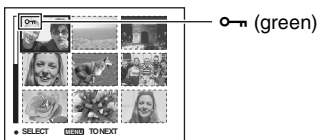

- ⑥ Repeat step ⑤ to protect other images.
- ⑦ Press MENU.
- ⑧ Select [OK] by moving to ▶, then press the center of the multi-selector.  
The Protect indicator turns white. The selected images are protected.

- To protect all images in the folder, select [All In This Folder] in step ④, and press the center of the multi-selector. Select [On] by moving to ►, then press the center of the multi-selector.

## To cancel the protection

In single-image mode

Press the center of the multi-selector in step ③ or ④ of “To protect images in single-image mode.”

In index mode

- ① Select the image for which you want to remove protection in step ⑤ of “To protect images in index mode.”
- ② Press the center of the multi-selector to turn the  indicator gray.
- ③ Repeat the operation above for all images to be unprotected.
- ④ Press MENU, select [OK] by moving the multi-selector to ►, and then press the center of the multi-selector.

## To cancel protection of all images in the folder

Select [All In This Folder] in step ④ of “To protect images in index mode,” and press the center of the multi-selector. Select [Off] by moving the multi-selector to ►, then press the center of the multi-selector.

- Note that formatting the recording medium erases all the data stored on the recording medium, even if images are protected, and these images cannot be recovered.
- It may take some time to protect an image.

## DPOF

Adds a  (Print order) mark to images you want to print (page 103).

## (Print)

See page 99.

## (Slide)

Plays back recorded images in order (Slide show).

**Interval**

✓	3 sec	Sets the slide show interval.
	5 sec	
	10 sec	
	30 sec	
	1 min	

**Image**

✓	Folder	Plays back all images in the selected folder.
	All	Plays back all images stored on the recording medium.

**Repeat**

✓	On	Plays back images in a continuous loop.
	Off	After all the images have been played back, the slide show ends.
	Start	See the following procedure.
✓	Cancel	Cancels the slide show.

① Select [Interval], [Image] and [Repeat] by moving the multi-selector to ▲/▼/◀/▶.

② Select [Start] by moving to ▼/▶, then press the center of the multi-selector.  
The slide show starts.

To end the slide show, press the center of the multi-selector, select [Exit] by moving to ▶, then press the center of the multi-selector.

- During a slide show, you can display the previous/next image by moving to ◀/▶.
- The interval time is just a guideline, so it may vary depending on the image size, etc.

** (Resize)**

You can change the image size of a recorded image (Resize), and save it as a new file. The original image is retained even after resizing.

	10M	The setting size is just a guideline. → page 13
	7M	
	5M	
	3M	
	1M	
✓	Cancel	Cancels resizing.

- ① Display the image you want to resize.
  - ② Press MENU to display the menu.
  - ③ Select [⏏] (Resize) by moving the multi-selector to ◀/▶, then press the center of the multi-selector.
  - ④ Select the desired size by moving to ▲/▼, then press the center of the multi-selector.  
The resized image is recorded in the recording folder as the newest file.
- For details on [Image Size] → step 4 in “Read This First”
  - You cannot change the size of RAW data files.
  - When you change from a small size to a large size, the image quality deteriorates.

### ⏏ (Rotate)



Rotates a still image.

		Rotates an image. See the following procedure.
	OK	Determines the rotation. See the following procedure.
✓	Cancel	Cancels rotation.

- ① Display the image to be rotated.
  - ② Press MENU to display the menu.
  - ③ Select [⏏] (Rotate) by moving the multi-selector to ◀/▶, then press the center of the multi-selector.
  - ④ Select [↻] by moving to ▲, then rotate the image by moving to ◀/▶.
  - ⑤ Select [OK] by moving to ▲/▼, then press the center of the multi-selector.
- You cannot rotate protected images, or RAW data files.
  - You may not be able to rotate images shot with other cameras.
  - When viewing images on a computer, the image rotation information may not be reflected depending on the software.

### ⏏ (Setup)

See pages 32, 71.

## Trimming

Records an enlarged image (→ step 6 in “Read This First”) as a new file.

	Trimming	See the following procedure.
✓	Return	Cancels trimming.

- ① Press MENU during playback zoom to display the menu.
  - ② Select [Trimming] by moving the multi-selector to ►, then press the center of the multi-selector.
  - ③ Select the image size by moving to ▲/▼, then press the center of the multi-selector.  
The image is recorded, and the original image is displayed again.
- Note that the edges of the upper and lower portions of the displayed image are cut off and their image size ratio becomes 3:2.
  - The trimmed image is recorded as the newest file in the selected recording folder, and the original image is retained.
  - The quality of trimmed images may deteriorate.



# Camera 1

The default settings are marked with ✓.

## AF Mode

Selects the auto focus operation mode.

	Single (S AF)	For details, see page 47.
✓	Monitor (M AF)	
	Continuous (C AF)	

## Digital Zoom

Enlarges the images using digital processing. The camera uses either smart or precision digital zoom.

	Smart (Smart zoom) ( <b>SQ</b> )	Enlarges the image digitally with almost no distortion. This is not available when the image size is set to [10M]. • The maximum zoom scale of Smart zoom is shown in the following table.
✓	Precision (Precision digital zoom) ( <b>PQ</b> )	Enlarges all image sizes up to a maximum of 10x, but the image quality deteriorates.

- The maximum zoom scale of smart zoom/precision zoom includes the scale of the optical zoom.
- The AF range finder frame does not appear when using the digital zoom. The or indicator flashes, and AF operates with priority on subjects located near the center of the frame.

## To do digital zooming

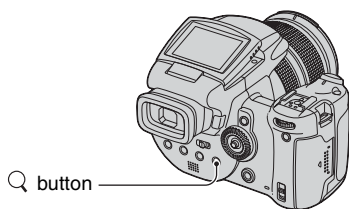

Press **Q** (Digital zoom). To cancel the digital zoom, press **Q** again. The zoom scaling returns to the number that was in effect using the optical zoom.

On the [Smart]

- The maximum zoom scale is as follows and it depends on the image size. The zoom scale displayed on the screen is an approximate value.

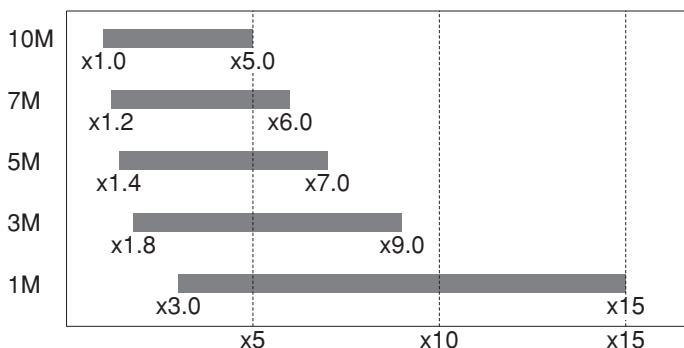

- When using the smart zoom, the image on the screen may look rough. However, this phenomenon has no effect on the recorded image.

## Power Save

When shooting, set the time to turn the camera to the power save mode. When the camera is in power save mode, the POWER lamp changes from green to red.

<input type="checkbox"/>	10 min	The camera turns to power save mode after 10 minutes.
<input type="checkbox"/>	3 min	The camera turns to power save mode after three minutes.
<input checked="" type="checkbox"/>	1 min	The camera turns to power save mode after one minute.
<input type="checkbox"/>	20 sec	The camera turns to power save mode after 20 seconds.
<input type="checkbox"/>	Off	Does not use the Power Save function.

## To cancel the power save mode

Pressing the shutter button returns the camera to the shooting mode, and pressing the  (Playback) button returns the camera to the playback mode.

- During the power save mode, the battery is still consumed since the power is not turned off.
- When the camera is in playback mode or the  (Setup) screen is displayed, the time is automatically set to three minutes and you cannot set it to [Off].
- When the FINDER/AUTO/LCD switch is set to FINDER or AUTO, the camera recognizes that the camera is not being operated if you put your face closer to the finder and leave it there. In such cases, the camera turns to power save mode after the selected time.
- Power save mode is not available when using the AC Adaptor or Remote Commander (not supplied).



## Date/Time

Selects how to superimpose the date or time onto the image. Select this before shooting.

- The date and time do not appear during shooting, instead, the **DATE** indicator appears. The date and time appear in red on the lower-right corner of the screen during playback only.

	Day&Time	Superimposes the date, hour, and minute.
	Date	Superimposes the year, month and day. <ul style="list-style-type: none"> <li>The date is inserted in the order you select. (→ step 2 in “Read This First”)</li> </ul>
✓	Off	Does not superimpose the date and time.

- The date and time superimposed cannot be removed later.

## AF Illuminator

The AF illuminator supplies fill light to focus more easily on a subject in dark surroundings. The AF illuminator emits red light allowing the camera to focus easily when the shutter button is pressed halfway, until the focus is locked. The **AF-ON** indicator appears at this time.

✓	Auto	Uses the AF illuminator.
	Off	Does not use AF illuminator.

- If the AF illuminator light does not reach the subject sufficiently or the subject has no contrast, focus will not be achieved. (A distance of up to approximately 2.7 m (106 1/4 inches) (zoom:W)/2.3 m (90 1/2 inches) (zoom:T) is recommended.)
- Focus is achieved as long as the AF illuminator light reaches the subject, even if the light is slightly off the center of the subject.
- When using manual focus (page 48), AF Illuminator does not function.
- The AF range finder frame does not appear. The **AF**, **AF** or **AF** indicator flashes, and AF operates with priority on subjects located near the center of the frame.
- The AF illuminator does not operate when **☾** (Twilight mode) or **▲** (Landscape mode) is selected in the Scene mode or using the PUSH AUTO function.
- The AF illuminator emits very bright light. Although there are no problems with safety, do not look directly into the AF illuminator emitter at close range.

## Auto Review

Displays the recorded image on the screen for approximately two seconds immediately after shooting a still image.

	On	Use the Auto Review.
✓	Off	Does not use Auto Review.

- If you press the shutter button halfway down during this period, the recorded image display disappears and you can immediately shoot the next image.
- The recorded image is displayed in Burst or Exposure Bracket mode regardless of the setting.

The default settings are marked with ✓.

### Expanded Focus

Expands the area around the PUSH AF/Expanded focus frame double in manual focus mode (page 48).

✓	On	Enlarges double.
	Off	Does not expand.

- When the precision digital zoom is activated or the smart zoom is activated with the image size set to [1M], the expanded focus function is not available.

### Flash Sync.

Selects the timing that the flash strobes.

✓	Front	For details, see page 52.
	Rear ( <b>REAR</b> )	

### Flash

Selects whether you use an external flash.

	Ext. (EXT <del>4</del> )	For details, see page 52.
✓	Int.	

### Pop-up Flash

Sets the flash to pop-up automatically or to do manually.

✓	Auto	For details, see page 51.
	Manual	

### Flicker Reduction



Selects the power supply frequency.

	60Hz	For details, see page 61.
	50Hz	
✓	Auto	

## Grid Line

Selects whether to display the grid lines or not.

<input type="checkbox"/>	On	For details, see page 60.
<input checked="" type="checkbox"/>	Off	

This item appears only when the /CF switch is set to “”.  
The default settings are marked with ✓.

## Format

Formats the “Memory Stick”. A commercially available “Memory Stick” is already formatted, and can be used immediately.

- Note that formatting irrevocably erases all data on a “Memory Stick”, including even protected images.

	OK	See the following procedure.
✓	Cancel	Cancels the formatting.

- ① Select [OK] by moving the multi-selector to ▲, then press the center of the multi-selector.  
The message “All data in Memory Stick will be erased Ready?” appears.
- ② Select [OK] by moving to ▲, then press the center of the multi-selector.  
The format is complete.

## Create REC. Folder

Creates a folder in a “Memory Stick” for recording images.

	OK	See the following procedure.
✓	Cancel	Cancels folder creation.

- ① Select [OK] by moving the multi-selector to ▲, then press the center of the multi-selector.  
The folder creation screen appears.

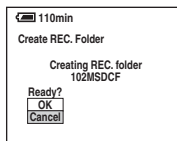

- ② Select [OK] by moving to ▲, then press the center of the multi-selector.  
A new folder is created with a number incremented one higher than the largest number, and the folder becomes the current recording folder.

- For details on the folder, see page 65.
- When not creating a new folder, the “101MSDCF” folder is selected as the recording folder.
- You can create folders designated up to “999MSDCF.”
- Images are recorded in the newly created folder until a different folder is created or selected.
- You cannot delete a folder with the camera. To delete a folder, use your computer, etc.
- Up to 4,000 images can be stored in one folder. When the folder capacity is exceeded, a new folder is automatically created.
- For more information, see “Image file storage destinations and file names” (page 90).

## Change REC. Folder

Changes the folder currently used for recording images.

	OK	See the following procedure.
✓	Cancel	Cancels changing the recording folder.

- ① Select [OK] by moving the multi-selector to ▲, then press the center of the multi-selector.  
The folder selection screen appears.

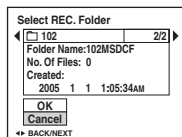

- ② Select the desired folder by moving to ◀/▶, and [OK] by moving to ▲, then press the center of the multi-selector.
- You cannot select the “100MSDCF” folder as a recording folder.
  - You cannot move recorded images to a different folder.

This item appears only when the /CF switch is set to “CF”.  
The default settings are marked with ✓.

### Format

Formats the Microdrive/CF card.

- Note that formatting irrevocably erases all data on a Microdrive/CF card, including even protected images.

	OK	See the following procedure.
✓	Cancel	Cancels the formatting.

- ① Select [OK] by moving the multi-selector to ▲, then press the center of the multi-selector.  
The message “All data in CF card will be erased Ready?” appears.
- ② Select [OK] by moving to ▲, then press the center of the multi-selector.  
The format is complete.

- You cannot format it using the Memory Stick Duo Adaptor that is compliant with the CompactFlash slot.

### Create REC. Folder

Creates a folder in a Microdrive/CF card for recording images.

	OK	See the following procedure.
✓	Cancel	Cancels folder creation.

- ① Select [OK] by moving the multi-selector to ▲, then press the center of the multi-selector.  
The folder creation screen appears.

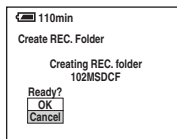

- ② Select [OK] by moving to ▲, then press the center of the multi-selector.  
A new folder is created with a number incremented one higher than the largest number, and the folder becomes the current recording folder.

- For details on the folder, see page 65.
- When not creating a new folder, the “101MSDCF” folder is selected as the recording folder.
- You can create folders designated up to “999MSDCF.”
- Images are recorded in the newly created folder until a different folder is created or selected.
- You cannot delete a folder with the camera. To delete a folder, use your computer, etc.
- Up to 4,000 images can be stored in one folder. When the folder capacity is exceeded, a new folder is automatically created.
- For more information, see “Image file storage destinations and file names” (page 90).

## Change REC. Folder

Changes the folder currently used for recording images.

	OK	See the following procedure.
✓	Cancel	Cancels changing the recording folder.

- ① Select [OK] by moving the multi-selector to ▲, then press the center of the multi-selector.  
The folder selection screen appears.

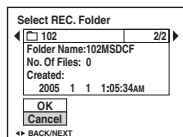

- ② Select the desired folder by moving to ◀/▶, and [OK] by moving to ▲, then press the center of the multi-selector.
- You cannot select the “100MSDCF” folder as a recording folder.
  - You cannot move recorded images to a different folder.

The default settings are marked with ✓.

### LCD Backlight

Selects the brightness of the LCD backlight when using the camera with battery pack.

	Bright	Brightens.
✓	Normal	
	Dark	Darkens.

- Selecting [Bright] uses up the battery pack charge faster.

### EVF Backlight

Selects the brightness of the finder backlight.

	Bright	Brightens.
✓	Normal	
	Dark	Darkens.

- Selecting [Bright] uses up the battery pack charge faster.

### Beep

Selects the sound produced when you operate the camera.

	Shutter	Turns on the shutter sound when you press the shutter button.
✓	On	Turns on the beep/shutter sound when you press the multi-selector/ press the shutter button.
	Off	Turns off the beep/shutter sound.

### Zebra

Selects whether to display the zebra pattern or not.

	On	For details, see page 42.
✓	Off	

### Language

Selects the language to be used to display the menu items, warnings, and messages.



The default settings are marked with ✓.

## File Number

Selects the method used to assign file numbers to images.

✓	Series	Assigns numbers to files in sequence even if the recording folder or the recording medium is changed. (When the replaced recording medium contains a file with a number higher than the last assigned number, a number one higher than the largest number is assigned.)
	Reset	Starts from 0001 each time the folder is changed. (When the recording folder contains a file, a number one higher than the largest number is assigned.)

## USB Connect

Selects the USB mode to be used when connecting the camera to a computer or a PictBridge compliant printer using the USB cable.

	PictBridge	Connects the camera to a PictBridge compliant printer (page 99).
	PTP	When [PTP] (Picture Transfer Protocol) is set and the camera is connected to a computer, the images in the recording folder on the camera are copied to the computer. (Compatible with Windows XP and Mac OS X.)
	Mass Storage	Establishes a Mass Storage connection between the camera and a computer or other USB device (page 87).
✓	Auto	<p>The camera recognizes automatically and sets up communication with a computer or PictBridge compliant printer (pages 87 and 99).</p> <ul style="list-style-type: none"> <li>• If the camera and a PictBridge compliant printer cannot be connected when set to [Auto], change the setting to [PictBridge].</li> <li>• If the camera and a computer or other USB device cannot be connected when set to [Auto], change the setting to [Mass Storage].</li> </ul>

## Video Out

Sets the video signal output according to the TV color system of the connected video equipment. Different countries and regions use different TV color systems. If you want to view images on a TV screen, check page 106 for the TV color system of the country or region where the camera is used.

NTSC	Sets the video output signal to NTSC mode (e.g., for the USA, Japan).
PAL	Sets the video output signal to PAL mode (e.g., for Europe).

## Clock Set

Sets the date and time.

	OK	Select [OK] by moving the multi-selector to ▲, and press the center of the multi-selector. Then, perform the procedure explained in “Set the clock” (→ step 2 in “Read This First”).
✓	Cancel	Cancels setting the clock.



# Enjoying your Windows computer

For details on using a Macintosh computer, refer to “Using your Macintosh computer” (page 95).



## Copying images to your computer (page 85)

### Preparation



Viewing images on your computer

Installing the USB driver.  
• Installation of the USB driver is not needed when using Windows XP.

## Enjoying images using “PicturePackage” (page 93)



Viewing images saved on your computer

Installing “PicturePackage” (page 93).



Storing images on a CD-R



Creating a Music Video/ Slideshow



Printing images

## Creating a video CD using “ImageMixer” (page 93)



Creating a video CD

“ImageMixer VCD2” is installed automatically when “PicturePackage” is installed.

## Recommended computer environment

The following environment is recommended for a computer connected to the camera.

### Recommended environment for copying images

**OS (pre-installed):** Microsoft Windows 98, Windows 98SE, Windows 2000 Professional, Windows Millennium Edition, Windows XP Home Edition, or Windows XP Professional

- Operation is not assured in an environment based on an upgrade of the operating systems described above or in a multi-boot environment.

**CPU:** MMX Pentium 200 MHz or faster

**USB connector:** Provided as standard

**Display:** 800 × 600 dots or more, High Color (16-bit color, 65,000 colors) or more

### Recommended environment for using “PicturePackage”/“ImageMixer VCD2”

**Software:** Macromedia Flash Player 6.0 or later, Windows Media Player 7.0 or later, DirectX 9.0b or later

**Sound card:** 16-bit stereo sound card with speakers

**Memory:** 64 MB or more (128 MB or more is recommended.)

**Hard Disk:** Disk space required for installation—approximately 500 MB

**Display:** Video card (Direct Draw driver compliant) with 4 MB of VRAM

- For automatic creation of a Music Video/ Slideshow (page 93), a Pentium III 500 MHz or faster CPU is required.
- When using “ImageMixer VCD2,” a Pentium III 800 MHz or faster CPU is recommended.
- This software is compatible with DirectX technology. “DirectX” must be installed for use.

- A separate software application for operating the recording device is required in order to write to CD-Rs.

### Recommended environment for using “Image Data Converter SR Ver.1.0”

**OS (pre-installed):** Microsoft Windows 2000 Professional, Windows XP Home Edition, or Windows XP Professional

**CPU:** MMX Pentium III 1 GHz or faster

**Memory:** 256 MB or more (512 MB or more is recommended.)

**Virtual memory:** 700 MB or more

**Display:** 1024 × 768 dots or more, High Color (16-bit color, 65,000 colors) or more

### Notes on connecting your camera to a computer

- Operations are not guaranteed for all the recommended computer environments mentioned above.
- If you connect two or more USB devices to a single computer at the same time, some devices, including your camera, may not operate, depending on the types of USB devices you are using.
- Operations are not guaranteed when using a USB hub.
- Connecting your camera using a USB interface that is compatible with Hi-Speed USB (USB 2.0 compliant) allows advanced transfer (high speed transfer) as this camera is compatible with Hi-Speed USB (USB 2.0 compliant).
- There are three modes for a USB connection when connecting a computer, [Auto] (default setting), [Mass Storage] and [PTP] modes. This section describes the [Auto] and [Mass Storage] as examples. For details on [PTP], see page 81.
- When your computer resumes from a suspend or sleep mode, communication between your camera and your computer may not recover at the same time.

# Copying images to your computer

This section describes the process using a Windows computer as an example. You can copy images from the camera to your computer as follows.

## For directly inserting the recording medium in a computer

Remove the recording medium from the camera and insert it in the computer and copy the images.

## For connecting the camera with the recording medium inserted to a computer using the USB connection

Follow Stages 1 through 5 on pages 85 to 89 to copy images.

- The screen displays shown in this section are the examples for copying images from “Memory Stick”.

### Stage 1: Installing the USB Driver

98 98SE 2000 Me

- A driver is software that enables equipment connected to the computer to operate properly.
- When using Windows XP, start from Stage 2.
- When “PicturePackage” is already installed, start from Stage 2.



**NOTE: Do not connect the camera to the computer at this time.**

## 1 Shut down all application software in use.

- In Windows 2000, log on as Administrator (authorized Administrators).

## 2 Insert the CD-ROM (Cyber-shot application software) into the computer, then click [USB Driver] when the install menu screen appears.

The “InstallShield Wizard” screen appears.

- If the install menu screen does not appear, double-click  (My Computer) →  (PICTUREPACKAGE).

## 3 Click [Next].



The USB driver installation starts. When the installation is finished, the screen informs you of completion.

## 4 Click the radio button next to [Yes, I want to restart my computer now] to select it, then click [Finish].



Your computer restarts. Now, you can establish a USB connection.

Remove the CD-ROM when the installation is completed.

## Stage 2: Preparing the camera and the computer

### 1 Insert a recording medium with recorded images into the camera.

- Use the  /CF switch to select the recording medium (→ step 3 in “Read This First”).

### 2 Connect the camera to a wall outlet (wall socket) with the AC Adaptor.

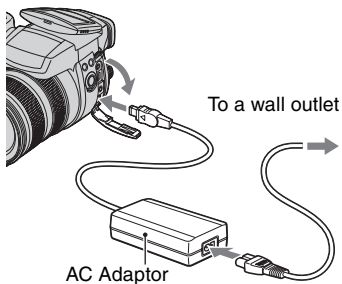

- When you copy images to your computer using the battery pack, copying may fail or image data may become corrupted if the battery pack shuts down too soon.

### 3 Turn on the camera and the computer.

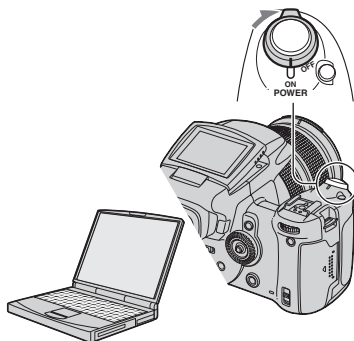

## Stage 3: Connecting the camera and your computer

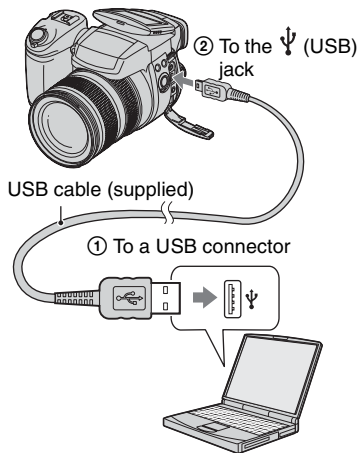

- With Windows XP, the AutoPlay wizard appears on the desktop.

“USB Mode Mass Storage” appears on the screen of the camera.

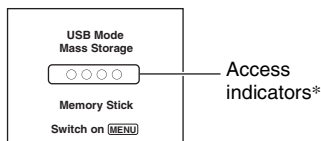

When a USB connection is established for the first time, your computer automatically runs a program to recognize the camera. Wait for a while.

- \* During communication, the access indicators turn red. Do not operate the computer until the indicators turn white.
- Opening the “Memory Stick”/CF card cover cancels the USB connection. Do not open the “Memory Stick”/CF card cover during a USB connection.
- If “USB Mode Mass Storage” does not appear, set [USB Connect] to [Mass Storage] (page 81).

## Stage 4-A: Copying images to a computer

XP

- For Windows 98/98SE/2000/Me, follow the procedure explained in “Stage 4-B: Copying images to a Computer” on page 88.
- For Windows XP, when the wizard screen does not appear automatically, follow the procedure explained in “Stage 4-B: Copying images to a Computer” on page 88.

This section describes an example of copying images to a “My Documents” folder.

- 1 After making a USB connection in Stage 3, click [Copy pictures to a folder on my computer using Microsoft Paint and Camera Wizard] → [OK] as the wizard screen appears automatically on the desktop.

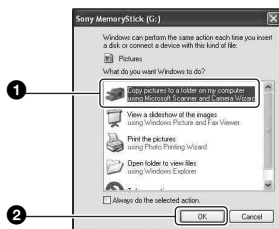

The “Scanner and Camera Wizard” screen appears.

- 2 Click [Next].

The images saved on the recording medium of the camera appear.

- 3** Click the check box of unwanted images to remove the checkmark so they are not copied, then click [Next].



The “Picture Name and Destination” screen appears.

- 4** Select a name and destination for the images, then click [Next].

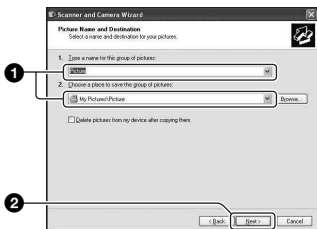
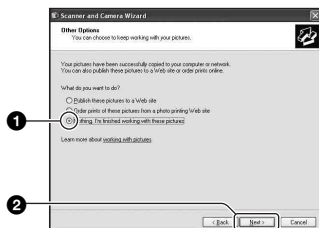

Image copying starts. When the copying is completed, the “Other Options” screen appears.

- This section describes an example of copying images to the “My Documents” folder.

- 5** Click the radio button next to [Nothing. I'm finished working with these pictures] to select it, then click [Next].



The “Completing the Scanner and Camera Wizard” screen appears.

- 6** Click [Finish].

The wizard screen closes.

- To continue copying other images, disconnect the USB cable (page 90). Then follow the procedure explained in “Stage 3: Connecting the camera and your computer” on page 87.

## Stage 4-B: Copying images to a Computer

98 98SE 2000 Me

- For Windows XP, follow the procedure explained in “Stage 4-A: Copying images to a computer” on page 87.

This section describes an example of copying images to the “My Documents” folder.



# 1 Double-click [My Computer] → [Removable Disk] → [DCIM].

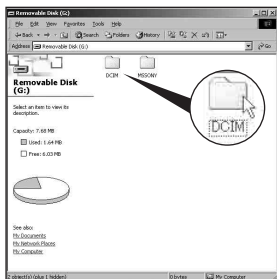

- If the "Removable Disk" icon is not displayed, see page 113.

# 2 Double-click the folder where the image files you want to copy are stored. Then, right-click an image file to display the menu and click [Copy].

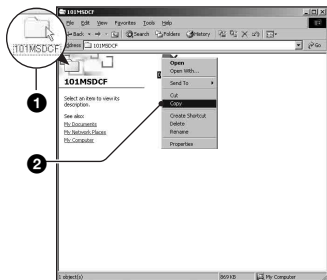

# 3 Double-click the [My Documents] folder. Then, right-click on the "My Documents" window to display the menu and click [Paste].

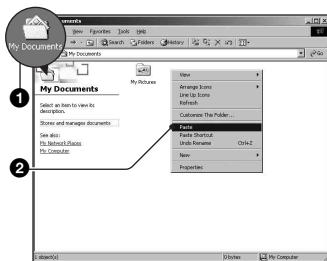

The image files are copied to the "My Documents" folder.

- When an image with the same file name exists in the copy destination folder, the overwrite confirmation message appears. When you overwrite an existing image with a new one, the original data is deleted. To copy an image file to the computer without overwriting, change the file name to a different name and then copy the image file. However, note that if you change the file name (page 92), you may not be able to play back that image with your camera.

## Stage 5: Viewing images on your computer

This section describes the procedure for viewing copied images in the "My Documents" folder.

# 1 Click [Start] → [My Documents].



The contents of the “My Documents” folder are displayed.

- If you are not using Windows XP, double-click [My Documents] on the desktop.

## 2 Double-click the desired image file.

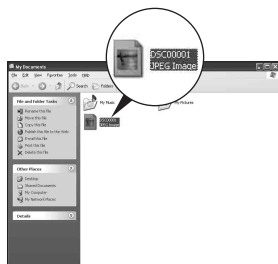

The image is displayed.

- The color of an image recorded in Adobe RGB mode may differ between the displayed image and the printed image, depending on the monitor.

## To delete the USB connection

Perform the procedures listed below beforehand when:

- Disconnecting the USB cable
- Removing a recording medium
- Turning off the camera
- Switching the recording medium using the  /CF switch

### ■ For Windows 2000/Me/XP

- ① Double-click  on the tasktray.



Double-click here

- ② Click  (Sony DSC) → [Stop].

- ③ Confirm the device on the confirmation window, then click [OK].
- ④ Click [OK].  
The device is disconnected.
  - Step 4 is unnecessary for Windows XP.

### ■ For Windows 98/98SE

Confirm that the access indicators (page 87) are white. If the access indicators have turned white, the device is disconnected from a computer.

## Image file storage destinations and file names

The image files recorded with your camera are grouped as folders on the recording medium.

### Example: viewing folders on Windows XP (when using a “Memory Stick”)

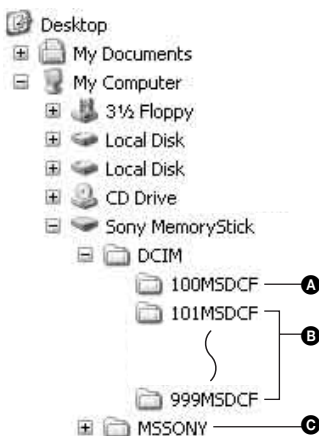

- A Folder containing image data recorded using a camera not equipped with the folder creating function.
- B Folder containing image data recorded using this camera.  
When no new folders are created, there is only the “101MSDCF” folder.

- **C** Folder containing movie data, etc., recorded using a camera not equipped with the folder creating function.
- Even when using a Microdrive/CF card, “Sony MemoryStick” may be displayed, depending on your computer environment.
- You cannot record any images to the “100MSDCF” folder. The images in these folders are available only for viewing.
- You cannot record/playback any images to the “MSSONY” folder.
- Image files are named as follows. □□□□ stands for any number within the range from 0001 to 9999. The numerical portions of the name of a RAW data file and its corresponding JPEG image file are the same.
  - Still image files: DSC0□□□□.JPG
  - Adobe RGB data files: \_DSC□□□□.JPG
  - RAW data file (other than Adobe RGB): DSC0□□□□.SR2
  - RAW data file (Adobe RGB): \_DSC□□□□.SR2
- For more information about folders, see pages 65, 76, 78.

# Viewing image files stored on a computer with your camera

This section describes the process using a Windows computer as an example.

When an image file copied to a computer no longer remains on a recording medium, you can view that image again on the camera by copying the image file on the computer to a recording medium.

- Step 1 is not necessary if the file name set with your camera has not been changed.
- You may be unable to play back some images depending on the image size.
- When an image file has been processed by a computer or when the image file was recorded using a model other than that of your camera, playback on your camera is not guaranteed.
- When there is no folder, first create a folder with your camera (pages 76, 78) and then copy the image file.

## 1 Right-click the image file, then click [Rename]. Change the file name to "DSC0□□□□."

Enter a number from 0001 to 9999 for □□□□.



- If the overwrite confirmation message appears, enter a different number.
- An extension may be displayed depending on the computer settings. The extension for still images is JPG. Do not change the extension.

## 2 Copy the image file to the recording medium folder in the following order.

- ① Right-click the image file, then click [Copy].
- ② Double-click [Removable Disk] or [Sony MemoryStick] in [My Computer].
- ③ Right-click the [□□□MSDCF] folder in the [DCIM] folder, then click [Paste].
  - □□□ stands for any number within the range from 100 to 999.

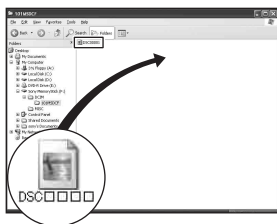

# Using the supplied software

This section describes the process using a Windows computer as an example.

## Overview of the supplied software

The supplied CD-ROM (Cyber-shot application software) contains two software applications: “PicturePackage” and “ImageMixer.”

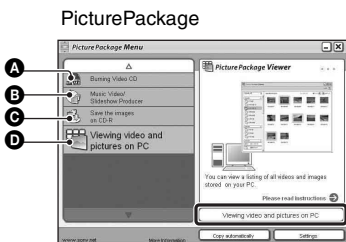

What you can do:

- A** Burning Video CD  
The “ImageMixer VCD2” screen appears.
- B** Music Video/Slideshow Producer
- C** Save the images on CD-R
- D** Viewing video and pictures on PC

How to start up the functions:  
Click one of **A–D**, then click the button at the lower right of the screen.



## Installing the software

You can install the “PicturePackage” and “ImageMixer VCD2” software using the following procedure.

- If you have not yet installed the USB driver (page 85), do not connect the camera to the computer before you install the “PicturePackage” software (except for Windows XP).
- In Windows 2000/XP, log on as Administrator.
- When “PicturePackage” is installed, the USB driver is installed automatically.

## 1 Turn on your computer, and insert the CD-ROM (supplied) into the CD-ROM drive.

The installation menu screen appears.

- If it does not appear, double-click  (My Computer) →  (PICTUREPACKAGE).

## 2 Click [PicturePackage].

The “Choose Setup Language” screen appears.

## 3 Select the desired language, then click [Next] twice.

This section describes the English screen.

The “License Agreement” screen appears.

Read the agreement carefully. If you accept the terms of the agreement, click the radio button next to [I accept the terms of the license agreement] and then click [Next].

## 4 Follow the instructions on the screen to complete the installation.

- “ImageMixer VCD2” and “DirectX” will be installed if you have not yet installed them.
- When the restarting confirmation message appears, restart the computer following the instructions on the screen.

- 
- 5 Remove the CD-ROM as the shortcut icons of “PicturePackage Menu” and “PicturePackage destination Folder” are displayed after the installation.**
- 

### To start up the software

- Double-click the “PicturePackage Menu” icon on the desktop.

### For information on the use of the software

Click [?] at the upper-right corner of each screen to show the on-line help.

Technical support for “PicturePackage”/“ImageMixer VCD2” is provided by the Pixela User Support Center. For more support information, refer to the leaflet in the supplied CD-ROM package.

### Installing “Image Data Converter SR Ver. 1.0”

Using “Image Data Converter SR Ver. 1.0” stored on the CD-ROM supplied, you can edit images recorded in RAW mode with various corrections, such as tone curve, and sharpness. Also, you can save the images in a general-purpose file format.

---

- 1 Insert the CD-ROM (Image Data Converter SR Ver.1.0) into the computer.**

The “Choose Setup Language” screen appears.

- 
- 2 Select the desired language, then click [Next] twice.**

This section describes the English screen.

The “License Agreement” screen appears.

Read the agreement carefully. If you accept the terms of the agreement, click the radio button next to [I accept the terms of the license agreement] and then click [Next].

---

- 3 Follow the instructions on the screen to complete the installation.**

Your computer restarts.

---

- “Image Data Converter SR” can edit the color space of images regardless of the color reproduction mode used for images. Therefore, the term “Real” is used instead of “Adobe RGB”.

The relationship between the color reproduction mode and color space is as follows.

- The combination available with the camera

	Standard	Real	Vivid
sRGB	<input type="radio"/>		<input type="radio"/>
Adobe RGB		<input type="radio"/>	

- The combination available with “Image Data Converter SR”

	Standard	Real	Vivid
sRGB	<input type="radio"/>	<input type="radio"/>	<input type="radio"/>
Adobe RGB	<input type="radio"/>	<input type="radio"/>	<input type="radio"/>

Technical support of “Image Data Converter SR Ver.1.0” can be found at our Customer Support Website.  
<http://www.sony.net/>

# Using your Macintosh computer

You can copy images to your computer and create a video CD using “ImageMixer VCD2” (supplied).

## Recommended computer environment

### Recommended environment for copying images

**OS (pre-installed):** Mac OS 9.1, 9.2, or Mac OS X (v10.0 or later)

**USB connector:** Provided as standard

### Recommended environment for using “ImageMixer VCD2”

**OS (pre-installed):** Mac OS X (v10.1.5 or later)

**CPU:** iMac, eMac, iBook, PowerBook, Power Mac G3/G4/G5 series, Mac mini

**Memory:** 128 MB or more (256 MB or more is recommended.)

**Hard Disk:** Disk space required for installation—approximately 250 MB

**Display:** 1024 × 768 dots or more, 32,000 colors or more

- QuickTime 4 or later must be pre-installed. (QuickTime 5 or later is recommended.)

### Recommended environment for using “Image Data Converter SR Ver.1.0”

**OS (pre-installed):** Mac OS X (v10.3-10.4)

**CPU:** iMac, eMac, iBook, PowerBook, Power Mac G4/G5 series, Mac mini

**Memory:** 256 MB or more (512 MB or more is recommended.)

**Display:** 1024 × 768 dots or more, 32,000 colors or more

## Notes on connecting your camera to a computer

- Operations are not guaranteed for all the recommended computer environments mentioned above.
- If you connect two or more USB devices to a single computer at the same time, some devices, including your camera, may not operate depending on the types of USB devices you are using.
- Operations are not guaranteed when using a USB hub.
- Connecting your camera using a USB interface that is compatible with Hi-Speed USB (USB 2.0 compliant) allows advanced transfer (high speed transfer) as this camera is compatible with Hi-Speed USB (USB 2.0 compliant).
- There are three modes for a USB connection when connecting a computer, [Auto] (default setting), [Mass Storage] and [PTP] modes. This section describes the [Auto] and [Mass Storage] as examples. For details on [PTP], see page 81.
- When your computer resumes from the suspend or sleep mode, communication between your camera and your computer may not recover at the same time.

## Copying and viewing images on a computer

### 1 Prepare the camera and a Macintosh computer.

Perform the same procedure as that described in “Stage 2: Preparing the camera and the computer” on page 86.

### 2 Connect the USB cable.

Perform the same procedure as that described in “Stage 3: Connecting the camera and your computer” on page 87.

---

### 3 Copy image files to the Macintosh computer.

- ① Double-click the newly recognized icon → [DCIM] → the folder where the images you want to copy are stored.
- ② Drag and drop the image files to the hard disk icon.  
The image files are copied to the hard disk.
  - For details on the storage location of the images and file names, see page 90.

---

### 4 View images on the computer.

Double-click the hard disk icon → the desired image file in the folder containing the copied files to open that image file.

---

#### To delete the USB connection

Perform the procedures listed below beforehand when:

- Disconnecting the USB cable
- Removing a recording medium
- Turning off the camera
- Switching the recording medium using the  /CF switch.

#### Drag and drop the drive icon or the icon of the recording medium to the “Trash” icon.

The camera is disconnected from the computer.

- If you are using Mac OS X v10.0, perform the procedure above after you have turned your computer off.

### Creating a video CD using “ImageMixer VCD2”



- You can create an image file that is compatible with the video CD creation function. To save the data in the video CD format on a CD-R, you need Toast (not supplied) by Roxio.

#### To install “ImageMixer VCD2”

- Shut down all other application software before you install “ImageMixer VCD2.”
  - The display settings should be 1024 × 768 dots or higher and 32,000 colors or higher.
- ① Turn on your Macintosh computer, and insert the CD-ROM (supplied) into the CD-ROM drive.
  - ② Double-click the CD-ROM icon.
  - ③ Copy the [IMXINST.SIT] file in the [MAC] folder to the hard disk icon.
  - ④ Double-click the [IMXINST.SIT] file in the copy-to folder.
  - ⑤ Double-click the extracted [ImageMixer VCD2\_Install] file.
  - ⑥ After the user information screen appears, enter the desired name and password. The installation of the software starts.

#### To start up “ImageMixer VCD2”

Open [ImageMixer] in [Application], then double-click [ImageMixer VCD2].



## For information on the use of the software

Click [?] at the upper-right corner of each screen to show the on-line help.

Technical support for “ImageMixer VCD2” is provided by the Pixela User Support Center. For more support information, refer to the leaflet in the supplied CD-ROM package.

### Installing “Image Data Converter SR Ver. 1.0”

You can edit images recorded in RAW mode with various corrections, such as tone curve, sharpness. Also, you can save the images as a general-purpose file format.

- ① Turn on your Macintosh computer, and insert the CD-ROM (Image Data Converter SR) into the CD-ROM drive.
- ② Double-click the CD-ROM icon.
- ③ Copy the [IDCSR\_INST.pkg] file in the [MAC] folder to the hard disk icon.
- ④ Double-click the [IDCSR\_INST.pkg] file in the copy-to folder.  
Follow the instructions on the screen to complete the installation.
  - When the restarting confirmation message appears, restart the computer following the instructions on the screen.
  - For details on the note explaining the color reproduction mode and support information for “Image Data Converter SR Ver. 1.0”, see page 94.

# How to print still images

## Printing directly using a PictBridge compliant printer (page 99)



You can print images by connecting the camera directly to a PictBridge compliant printer.

## Printing directly using a “Memory Stick”/Microdrive/CF card compliant printer



You can print images with a “Memory Stick”/Microdrive/CF card compliant printer. For details, see the operating instructions supplied with the printer.

## Printing using a computer



You can copy images to a computer using the supplied “PicturePackage” software and print the images.

## Printing at a shop (page 103)



You can take a recording medium containing images shot with your camera to a photo printing service shop. You can make a  (Print order) mark on images that you want to print out in advance.

# Printing images directly using a PictBridge compliant printer

Even if you do not have a computer, you can print images shot using your camera by connecting the camera directly to a PictBridge compliant printer.

## PictBridge

- “PictBridge” is based on the CIPA standard. (CIPA: Camera & Imaging Products Association)

### In single-image mode

You can print a single image on a printing sheet.



### In index mode

You can print several images at a reduced size on a printing sheet. You can print a set of either the same images (1) or different images (2).

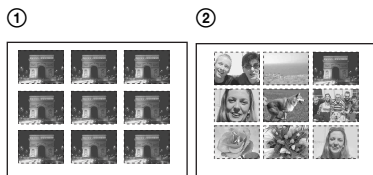

- An index print function may not be provided depending on the printer.
- The quantity of images that can be printed as an index image differ depending on the printer.
- You cannot print RAW data files.
- If the  indicator flashes on the screen of the camera for about five seconds (error notification), check the connected printer.

## Stage 1: Preparing the camera

Prepare the camera to connect it to the printer with the USB cable. When connecting the camera to a printer that is recognized when [USB Connect] is set to [Auto], Stage 1 (steps 1 - 4) is unnecessary.

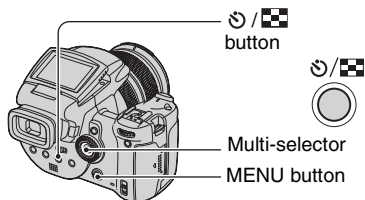

- It is recommended to use the AC Adaptor to prevent the power from turning off partway through printing.

**1** Press MENU to display the menu.

**2** Move the multi-selector to ► to select  (Setup).

**3** Select  (Setup2) by moving to ▼, then select [USB Connect] by moving to ▲/▼/►.

**4** Select [PictBridge] by moving to ►/▲, then press the center of the multi-selector.

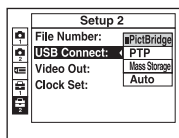

The USB mode is set.

---

## 5 Insert the recording medium that the images have been recorded.

- Use the /CF switch to select the recording medium.
- 

## Stage 2: Connecting the camera to the printer

Connect the  (USB) jack on your camera and the USB jack on the printer with the supplied USB cable.

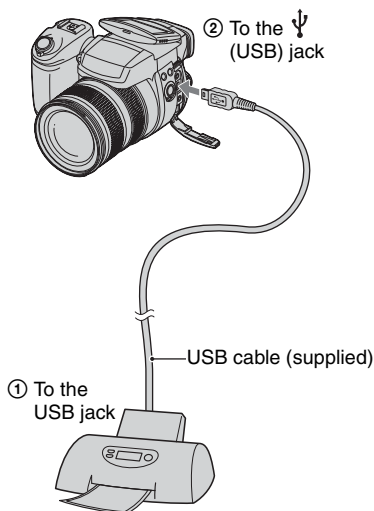

Turn on your camera and the printer.

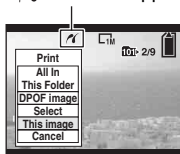

After the connection is made, the  indicator appears.



The camera is set to playback mode, then an image and the print menu appear on the screen.

## Stage 3: Printing

Pressing the  button is not required, the print menu appears when you complete Stage 2.

- 1 Select the desired printing method by moving the multi-selector to , then press the center of the multi-selector.

### [All In This Folder]





Prints all the images in the folder.

### [DPOF image]

Prints all the images with a  (Print order) mark (page 103) regardless of the displayed image.

### [Select]

Selects images and prints all the selected images.

- ① Select the image you want to print by moving to , then press the center of the multi-selector. The  mark appears on the selected image.
  - To select other images, repeat this procedure.
- ② Select [Print] by moving to , then press the center of the multi-selector.

### [This image]

Prints a displayed image.

- If you select [This image] and set [Index] to [On] in step 2, you can print a set of the same images as an index image.

## 2 Select print settings by moving to ▲/▼/◀/▶.

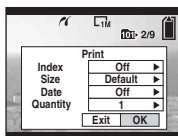

### [Index]

Select [On] to print as an index image.

### [Size]

Select the size of the printing sheet.

### [Date]

Select [Day&Time] or [Date] to insert the date and time on images.

- When you choose [Date], the date will be inserted in the order you select (→ *step 2 in "Read This First"*). This function may not be provided depending on the printer.

### [Quantity]

When [Index] is set to [Off]:

Select the number of sheets of an image that you want to print. The image will be printed as a single image.

When [Index] is set to [On]:

Select the number of sets of images that you want to print as an index image. If you selected [This image] in step 1, select the number of the same image you want to print side by side on a sheet as an index image.

- The designated number of images may not all fit onto a single sheet depending on the quantity of images.

## 3 Select [OK] by moving to ▼/▶, then press the center of the multi-selector.

The image is printed.

- Do not disconnect the USB cable while the  (Do not disconnect the USB cable) indicator appears on the screen.

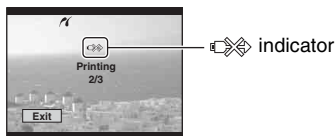



## To print other images

After step 3, select [Select] and the desired image by moving to ▲/▼, then perform from step 1.

## To print images on the index screen

Perform “Stage 1: Preparing the camera” (page 99) and “Stage 2: Connecting the camera to the printer” (page 100), then proceed with the following.

When you connect the camera to a printer, the print menu appears. Select [Cancel] to turn off the print menu, then proceed as follows.

- ① Press /  (Index).  
The index screen appears.
- ② Press MENU to display the menu.
- ③ Select [] (Print) by moving to ▶, then press the center of the multi-selector.
- ④ Select the desired printing method by moving to ▲/▼, then press the center of the multi-selector.

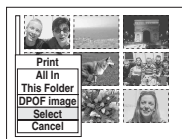

**[Select]**

Selects images and prints all the selected images.

Select the image you want to print by moving to ▲/▼/◀/▶, then press the center of the multi-selector to display the ✓ mark. (Repeat this procedure to select other images.) Then, press MENU.

**[DPOF image]**

Prints all the images with a  (Print order) mark regardless of the displayed image.

**[All In This Folder]**

Prints all the images in the folder.

- ⑤ Perform steps 2 and 3 of “Stage 3: Printing” (page 100).
-

# Printing at a shop

You can take a recording medium containing images shot with your camera to a photo printing service shop. As long as the shop supports photo printing services conforming to the DPOF, you can make a  (Print order) mark on images in advance so that you do not need to reselect them when you print them out at the shop.

## What is DPOF?

DPOF (Digital Print Order Format) is a function allowing you to make a  (Print order) mark on images of recording medium that you want to print out later.

- You can also print the images with the  (Print order) mark using a printer that conforms to the DPOF (Digital Print Order Format) standard or using a PictBridge compliant printer.
- You cannot mark RAW data files.

## When taking a recording medium to a shop

- Consult your photo printing service shop as to what types of recording medium they handle.
- If a “Memory Stick”, Microdrive, or CF card is not handled by your photo printing service shop, copy the images you want to print out to other medium such as a CD-R and take it to the shop.
- When you recorded on a “Memory Stick Duo”, be sure to take the Memory Stick Duo Adaptor with it.
- Before you take image data to a shop, always copy (back up) your data to a disk.
- You cannot set the number of prints.

## Marking in single-image mode

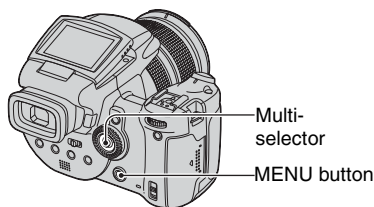



**1** Display the image you want to print.

**2** Press MENU to display the menu.

**3** Select DPOF by moving the multi-selector to , then press the center of the multi-selector.

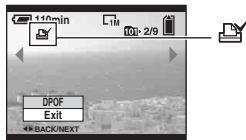
A  (Print order) mark is marked on the image.



**4** To mark other images, display the desired image by moving to , then press the center of the multi-selector.

## To remove the mark in single-image mode

Press the center of the multi-selector in step 3 or 4.

## Marking in index mode

**1** Display the index screen (→ *step 6 in "Read This First"*).

**2** Press MENU to display the menu.

**3** Select DPOF by moving the multi-selector to ◀▶, then press the center of the multi-selector.

**4** Select [Select] by moving to ▲▼, then press the center of the multi-selector.

- You cannot add a  mark in [All In This Folder].

**5** Select the image you want to mark by moving to ▲▼/◀▶, then press the center of the multi-selector.

A green  mark appears on the selected image.



Green  mark

**6** Repeat step 5 to mark other images.

**7** Press MENU.

**8** Select [OK] by moving to ▶, then press the center of the multi-selector.

The  mark turns white.

To cancel, select [Cancel] in step 4 or select [Exit] in step 8, then press the center of the multi-selector.

### To remove the mark in index mode

Select the images from which you want to remove the mark in step 5, then press the center of the multi-selector.

### To remove all the marks in the folder

Select [All In This Folder] in step 4, then press the center of the multi-selector. Select [Off], then press the center of the multi-selector.





## Viewing images on a TV screen

You can view images on a TV screen by connecting the camera to a TV.

Turn off both your camera and the TV before connecting the camera and the TV.

### 1 Use the video cable (supplied) to connect the camera to the TV.

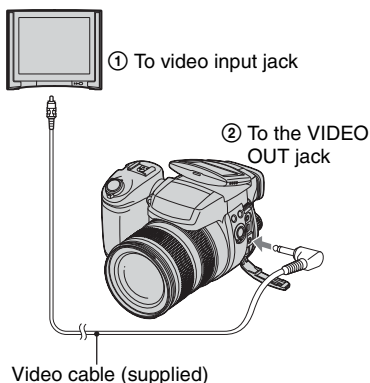



### 2 Turn on the TV and set the TV/ video input switch to “video.”

- For details, see the operating instructions supplied with the TV.

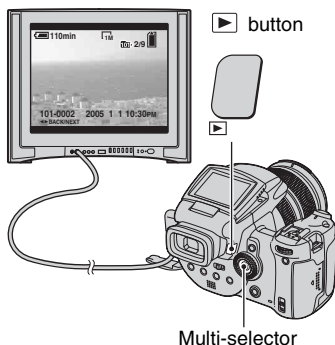
### 3 Turn on the camera, and press (Playback).



Images shot with the camera appear on the TV screen.

Move the multi-selector to   to select the desired image.

- When using your camera abroad, it may be necessary to switch the video signal output to match that of your TV system (page 82).
- When you display the images recorded in Adobe RGB mode on the camera or sRGB devices, such as on TVs/LCD monitors that are not compatible with Adobe RGB (DCF2.0/Exif2.21), the images are displayed by lower intensity level.

## **On TV color systems**

If you want to view images on a TV screen, you need a TV with a video input jack and the video cable (supplied). The color system of the TV must match that of your digital still camera. Check the following lists for the TV color system of the country or region where the camera is used.

### **NTSC system**

Bahama Islands, Bolivia, Canada, Central America, Chile, Colombia, Ecuador, Jamaica, Japan, Korea, Mexico, Peru, Surinam, Taiwan, the Philippines, the U.S.A., Venezuela, etc.

### **PAL system**

Australia, Austria, Belgium, China, Czech Republic, Denmark, Finland, Germany, Holland, Hong Kong, Hungary, Italy, Kuwait, Malaysia, New Zealand, Norway, Poland, Portugal, Singapore, Slovak Republic, Spain, Sweden, Switzerland, Thailand, United Kingdom, etc.

### **PAL-M system**

Brazil

### **PAL-N system**

Argentina, Paraguay, Uruguay

### **SECAM system**

Bulgaria, France, Guiana, Iran, Iraq, Monaco, Russia, Ukraine, etc.



If you experience trouble with your camera, try the following solutions.

**1 Check the items on pages 108 to 117.**

If a code such as “C/E:□□:□□” appears on the screen, see page 118.

**2 Press the RESET button using a pointed object, then turn on the power (reset).**

All the settings including date and time are cleared.

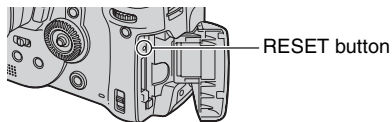

**3 Consult your Sony dealer or local authorized Sony service facility.**

## Battery pack and power

### You cannot charge the battery pack.

- A battery pack cannot be charged while the camera is turned on. Turn the camera off (→ *step 2 in “Read This First”*).

---

### The battery pack cannot be installed.

- As you insert the battery pack, use the tip of the battery pack to push the battery eject lever toward the front of the camera (→ *step 1 in “Read This First”*).
- Install the battery pack correctly (→ *step 1 in “Read This First”*).

---

### The $\zeta$ /Charge lamp flashes when charging a battery pack.

- Install the battery pack correctly (→ *step 1 in “Read This First”*).
- The battery pack is discharged. Disconnect the AC Adaptor and reconnect it, then charge the battery pack.
- The battery pack has malfunctioned. Consult your Sony dealer or local authorized Sony service facility.

---

### The $\zeta$ /Charge lamp does not light up when charging a battery pack.

- Properly connect the AC Adaptor.
- Install the battery pack correctly (→ *step 1 in “Read This First”*).
- The battery pack is fully charged.
- The battery pack is discharged. Disconnect the AC Adaptor and reconnect it, then charge the battery pack.
- The AC Adaptor has malfunctioned. Consult your Sony dealer or local authorized Sony service facility.

---

### The battery remaining indicator is incorrect, or sufficient battery remaining indicator is displayed but the power runs out too quickly.

- This phenomenon occurs when you use the camera in an extremely hot or cold location (page 125).
- The displayed time remaining differs from the current one. Fully discharge and then charge the battery pack to correct the display.
- The battery pack is discharged. Install the charged battery pack (→ *step 1 in “Read This First”*).
- The battery pack is dead (page 125). Replace it with new one.

---

### The battery pack runs down too quickly.

- Charge it sufficiently (→ *step 1 in “Read This First”*).
- You are using the camera in an extremely cold location (page 125).
- The battery terminal is dirty. Clean the battery terminal with a cotton swab, etc., and charge the battery pack.
- The battery pack is dead (page 125). Replace it with new one.
- Disconnect the DC plug from the camera when charging is complete.

---

**Cannot turn on the camera.**

- Install the battery pack correctly (→ *step 1 in “Read This First”*).
- Properly connect the AC Adaptor.
- The AC Adaptor has malfunctioned. Consult your Sony dealer or local authorized Sony service facility.
- The battery pack is discharged. Install charged battery pack (→ *step 1 in “Read This First”*).
- The battery pack is dead (page 125). Replace it with new one.

---

**The power turns off suddenly.**

- When the Power Save is turned on, if you do not operate the camera for certain period of time while the power is on, the camera turns to standby status automatically to prevent wearing down the battery pack. Press the shutter button or the  (Playback) button, or use the AC Adaptor (→ *step 2 in “Read This First”*).
- The battery pack is discharged. Install charged battery pack (→ *step 1 in “Read This First”*).

## Shooting still images

---

**The LCD screen does not turn on even when the power is turned on.**

- Set the FINDER/AUTO/LCD switch to other than FINDER (→ *step 5 in “Read This First”*).



---

**The image is not clear on the finder.**

- Adjust the diopter scale properly using the finder adjustment lever (→ *step 5 in “Read This First”*).

---

**Your camera cannot record images.**

- Check the free capacity of the recording medium (page 23). If it is full, do one of the following:
  - Delete unnecessary images (→ *step 6 in “Read This First”*).
  - Change the recording medium.
- Set the /CF switch to the proper position (→ *step 3 in “Read This First”*).
- Set the write-protect switch on the “Memory Stick” to the recording position (page 122).
- You cannot record images while charging the flash.
- The camera is in playback mode. Press the shutter button or the  (Playback) button to enter the recording mode (→ *step 6 in “Read This First”*).

---

**The subject is not visible on the screen.**

- The camera is in playback mode. Press the shutter button or the  (Playback) button to enter the recording mode (→ *step 6 in “Read This First”*).
- If you put your face close to the finder with the FINDER/AUTO/LCD switch set to AUTO, it may be switched to the finder automatically. Check the FINDER/AUTO/LCD switch.

---



**Recording takes a long time.**

- The NR slow shutter function is activated (page 37). This is not a malfunction.

- You are shooting in RAW mode (page 59). Since the RAW data file is large, the RAW mode shooting may take time.

---

### The image is out of focus.

- The subject is too close. Record in the close-up (Macro) recording mode. Make sure to position the lens farther away from the subject than the shortest shooting distance from the  $\phi$  base point of distance mark, approximately 35 cm (13 7/8 inches) (W)/40 cm (15 3/4 inches) (T), when shooting (→ *step 5 in “Read This First”*).
-  (Twilight mode) or  (Landscape mode) is selected in the Scene mode when shooting still images.
- When shooting in manual focus mode, set the FOCUS switch to AUTO (page 48).

---

### Precision digital zoom does not function.

- Set [Digital Zoom] to [Precision] (page 71).
- This function cannot be used while shooting in RAW mode (page 59).







---

### Smart zoom does not function.

- Set [Digital Zoom] to [Smart] (page 71).
- This function cannot be used when:
  - The image size is set to [10M].
  - Shooting in RAW mode.

---

### The flash does not work.

- The flash is set to  (No flash) (page 50).
- You cannot use the flash when:
  - Burst mode is selected (page 58).
  - Exposure bracket mode is selected (page 44).
  -  (Twilight mode) is selected in the Scene mode (page 30).
- Set the flash to  (Forced flash) or  (Forced flash with red-eye reduction) (page 50) when  (Landscape mode) is selected in the Scene mode.
- When [Pop-up Flash] is set to [Manual], press the  button to pop up the flash (page 51).



---

### Fuzzy specks appear in images shot using the flash.

- Dust in the air reflected the flash light and appeared in the image. This is not a malfunction.

---

### The close-up (Macro) function does not work.

-  (Twilight mode) or  (Landscape mode) is selected in the Scene mode (page 30).

---

### The date and time are recorded incorrectly.

- Set the correct date and time (→ *step 2 in “Read This First”*).

---

**The F value and shutter speed flash when you press and hold the shutter button halfway down.**

- The exposure is incorrect. Correct the exposure (pages 39, 41).

---

**The image is too dark.**

- You are shooting a subject with a light source behind the subject. Select the metering mode (page 40) or adjust the exposure (page 41).
- The brightness of the screen is too low. Adjust the brightness of the LCD backlight/finder backlight (page 80).

---

**The image is too bright.**

- You are shooting a spotlighted subject in a dark location such as on a stage. Adjust the exposure (page 41).
- The brightness of the screen is too bright. Adjust the brightness of the LCD backlight/finder backlight (page 80).

---

**The image colors are not correct.**

- Picture Effect function is activated. Cancel the Picture Effect function (page 63).

---

**Noise appears in the image when you view the screen in a dark place.**

- The camera is attempting to increase the visibility of the screen by temporarily brightening the image under conditions of low illumination (Auto brightness monitoring). There is no effect on the recorded image.

---

**Vertical streaks appear on the screen.**

- This is the flicker phenomenon. This is not a malfunction (page 61).
- When the setting of the power supply frequency is wrong, flicker may be generated. Check the setting of [Flicker Reduction] in the  (Setup) menu (page 61).

---

**The eyes of the subject come out red.**

- Activate the red eye reduction function (page 50).
- Shoot the subject at a distance closer than the recommended shooting distance using the flash (page 50).
- Light the room and shoot the subject.

---

**Zebra stripes appear on the screen.**

- [Zebra] is set to [On] (page 42). If it is not necessary, cancel it.

---

**Grid lines appear on the screen vertically and horizontally.**

- [Grid Line] is set to [On] (page 60). If it is not necessary, cancel it.



---

**Dots appear and remain on the screen.**

- This is not a malfunction. These dots are not recorded (page 5, → “*Read This First*”).

---

**Cannot shoot images in succession.**

- The recording medium is full. Delete unnecessary images (→ *step 6 in “Read This First”*).
- The battery level is low. Install charged battery pack.
-  (Twilight mode) or  (Twilight portrait mode) is selected in the Scene mode (page 30).

## Viewing images

Refer to “Computers” (page 113) in conjunction with the following items.

---

**Your camera cannot play back images.**

- Press the  (Playback) button to turn to playback mode (→ *step 6 in “Read This First”*).
- The folder/file name has been changed on your computer (page 92).
- When an image file has been processed by a computer or when the image file was recorded using a model other than that of your camera, playback on your camera is not guaranteed.
- The camera is in USB mode. Delete the USB connection (page 90).

---

**The image appears rough right after playback starts.**

- The image may appear rough right after playback starts due to image processing. This is not a malfunction.

---

**The image does not appear on the TV screen.**

- Check [Video Out] to see if the video output signal of your camera is set to the color system of your TV (page 82).
- Check whether the connection is correct (page 105).
- A USB cable is connected to the camera. Disconnect the USB cable following the proper procedure (page 90).

## Deleting/Editing images

---

**Your camera cannot delete an image.**

- Cancel the protection (page 67).
- Set the write-protect switch on the “Memory Stick” to the recording position (page 122).

---

**You have deleted an image by mistake.**

- Once you have deleted an image, you cannot restore it. We recommend that you protect images (page 66), or set the write-protect switch on the “Memory Stick” to the LOCK position (page 122) to prevent accidental erasure.



---

**The resizing function does not work.**

- You cannot resize RAW data files.

---

**You cannot display a DPOF (Print order) mark.**

- You cannot display DPOF (Print order) marks on RAW data files.

## Computers

---

**You do not know if the OS of your computer is compatible with the camera.**

- Check “Recommended computer environment” on page 84 for Windows, and page 95 for Macintosh.

---

**You cannot install the USB driver.**

- In Windows 2000, log on as Administrator (authorized Administrators) (page 85).

---

**Your computer does not recognize your camera.**

- Turn on the camera (→ *step 2 in “Read This First”*).
- When the battery level is low, use the AC Adaptor (→ *step 1 in “Read This First”*).
- Use the supplied USB cable (page 87).
- Disconnect the USB cable from both the computer and the camera, and connect it again firmly. Make sure that “USB Mode Mass Storage” is displayed (page 87).
- Set [USB Connect] to [Mass Storage] in the  (Setup) menu (page 81).
- Disconnect all equipment other than the camera, the keyboard and the mouse from the USB connectors of your computer.
- Connect the camera directly to your computer without passing through a USB hub or other device (page 87).
- The USB driver is not installed. Install the USB driver (page 85).
- Your computer does not properly recognize the device because you connected the camera and your computer with the USB cable before you installed the “USB Driver” from the supplied CD-ROM. Delete the erroneously recognized device from your computer, then install the USB driver (see the next item).

---

**The “Removable disk” icon does not appear on the computer screen when you connect your computer to the camera.**

- Follow the procedure below to install the USB driver again. The following procedure is for a Windows computer.
  - 1** Right-click [My Computer] to display the menu, then click [Properties].  
The “System Properties” screen appears.
  - 2** Click [Hardware] → [Device Manager].
    - For Windows 98/98SE/Me, click the [Device Manager] tab.  
The “Device Manager” appears.
  - 3** Right-click [ Sony DSC], then click [Uninstall] → [OK].  
The device is deleted.

4 Install the USB driver (page 85).

---

### **You cannot copy images.**

- Connect the camera and your computer correctly using the supplied USB cable (page 87).
  - Follow the designated copy procedure for your OS (pages 87, 95).
  - When you shoot images with a recording medium formatted by a computer, you may not be able to copy the images to a computer. Shoot using a recording medium formatted by your camera (page 76).
- 

### **After making a USB connection, “PicturePackage” does not start automatically.**

- Start up the “PicturePackage Menu” and check [Settings].
  - Make the USB connection after the computer is turned on (page 87).
- 

### **The image cannot be played back on a computer.**

- If you are using “PicturePackage,” click on help at the upper-right corner of each screen.
  - Consult the computer or software manufacturer.
- 

### **You cannot print an image.**

- Check the printer settings.
- 

### **Images once copied to a computer cannot be viewed on the camera.**



- Copy them to a folder recognized by the camera, such as “101MSDCF” (page 90).
  - Operate correctly (page 92).
- 

## **“Memory Stick”**

### **Cannot insert a “Memory Stick”.**

- Insert it in the correct direction (→ *step 3 in “Read This First”*).
- 

### **Cannot record on a “Memory Stick”.**

- Set the write-protect switch on the “Memory Stick” to the recording position (page 122).
  - The “Memory Stick” is full. Delete unnecessary images (→ *step 6 in “Read This First”*).
  - Set the /CF switch to “” (→ *step 3 in “Read This First”*).
- 

### **Cannot format a “Memory Stick”.**

- Set the write-protect switch on the “Memory Stick” to the recording position (page 122).
- 

### **You have formatted a “Memory Stick” by mistake.**

- All the data on the “Memory Stick” is deleted by formatting. You cannot restore it. We recommend that you set the write-protect switch on the “Memory Stick” to the LOCK position to prevent accidental erasure (page 122).

---

**“Memory Stick PRO” is not recognized by a computer with a “Memory Stick” slot.**

- Check whether the computer and the card reader support “Memory Stick PRO”. Users of computers and card readers made by companies other than Sony should contact those manufacturers.
- If “Memory Stick PRO” is not supported, connect the camera to the computer (pages 85 to 87). The computer recognizes the “Memory Stick PRO”.

**Microdrive/CF card****Cannot insert a Microdrive/CF card.**

- You try to insert an unusable CF card (page 124, → *step 3 in “Read This First”*).
- Insert it in the correct direction (→ *step 3 in “Read This First”*).

---

**Cannot record on a Microdrive/CF card.**

- The Microdrive/CF card is full. Delete unnecessary images (→ *step 6 in “Read This First”*).
- An unusable CF card is inserted (page 124, → *step 3 in “Read This First”*).
- The “Memory Stick”/CF card cover is open. Close the CF card cover (→ *step 3 in “Read This First”*).
- Set the /CF switch to “CF” (→ *step 3 in “Read This First”*).
- You are using the recording medium with the write-protect switch, and the switch is set to the LOCK position. Set the switch to the recording position.

---

**The Microdrive is heated.**

- You are using the Microdrive for a long time. This is not a malfunction.

---

**You have formatted a Microdrive/CF card by mistake.**

- All the data on the Microdrive/CF card is deleted by formatting. You cannot restore it.

**Printing**

Also see “PictBridge compliant printer” (as follows) in conjunction with the following items.

**The color of the image is strange.**

- When you print the images recorded in Adobe RGB mode using sRGB printers that are not compatible with Adobe RGB (DCF2.0/Exif2.21), the images are printed at a lower intensity level (page 57).

**PictBridge compliant printer****A connection cannot be established.**



- The camera cannot be connected directly to a printer that is not compliant with the PictBridge standard. Consult the printer manufacturer as to whether the printer is compliant with PictBridge or not.

- Check that the printer is turned on and can be connected to the camera.
  - When a recording medium, such as a “Memory Stick”, CF card, is not inserted to the camera the camera cannot connect to the printer. After you insert a recording medium, connect the printer again.
  - Set [USB Connect] to [PictBridge] in the  (Setup) menu (page 81).
  - Disconnect and connect the USB cable again. If an error message is indicated on the printer, refer to the operating instructions supplied with the printer.
- 

### **Cannot print images.**

- Check that the camera and the printer are properly connected using the USB cable.
  - Turn on the printer. For further information, refer to the operating instructions supplied with the printer.
  - If you select [Exit] during printing, images may not print. Disconnect and connect the USB cable again. If you still cannot print your images, disconnect the USB cable, turn the printer off and then on, then connect the USB cable again.
  - RAW data files cannot be printed.
  - Images shot using cameras other than this camera or images modified with a computer may not be printed.
- 

### **Printing is canceled.**

- You disconnected the USB cable before the  (Do not disconnect USB cable) mark disappears.
  - You changed the position of the  /CF switch while operating the camera.
- 

### **Cannot insert the date or print images in the index mode.**

- The printer does not provide these functions. Consult the printer manufacturer as to whether the printer provides these functions or not.
  - The date may not be inserted in the index mode depending on the printer. Consult the printer manufacturer.
- 

### **“---- -- --” is printed on the date-inserted part of the image.**

- Images that do not have the recording data cannot be printed with the date inserted. Set [Date] to [Off] and print the image again (page 101).
- 

### **Cannot select the print size.**

- Consult the printer manufacturer as to whether the printer can provide the desired size.
- 

### **Cannot print the image at the size selected.**

- Disconnect the USB cable and reconnect it whenever you change the paper size after the printer has been connected to the camera.
- The print setting of the camera differs from that of the printer. Change the setting of either the camera (page 101) or the printer.



---

### Cannot operate the camera after canceling printing.

- Wait for a while as the printer is carrying out the cancellation. It may take some time depending on the printer.

## Others

### Your camera does not work.

- Use the type of battery pack you can use with this camera (page 125).
- The battery level is low (The  indicator appears). Charge the battery pack (→ *step 1 in "Read This First"*).
- The camera is in power save mode. Press the shutter button or the  (Playback) button to cancel the power save mode.
- If you close the LCD screen toward the camera with the FINDER/AUTO/LCD switch set to LCD, you cannot operate the camera, such as the MENU button. Set the switch to FINDER or change the angle of the LCD screen.

---

### The power is on, but the camera does not work.

- The built-in microcomputer is not working properly. Remove the battery pack, and then, after one minute, insert the battery pack and turn on the camera. If this does not work, reset the camera (page 107).

---

### Cannot identify an indicator on the screen.

- See page 19.

---

### The lens gets fogged.

- Moisture condensation has occurred. Turn off the camera and leave it for about an hour before using it (page 126).

---

### The Clock Set screen appears when you turn on the camera.

- Set the date and time again (→ *step 2 in "Read This First"*).

---

### You cannot turn the camera on/off from an optional accessory, such as a Remote Commander.

- When the POWER switch of the camera is set to OFF, you cannot operate the camera from an optional accessory, such as a Remote Commander. Set the POWER switch to ON (→ *step 2 in "Read This First"*).

# Warning indicators and messages

## Self-diagnosis display

If a code starting with a letter of the alphabet appears, your camera has a self-diagnosis display. The last two digits (indicated by □□) will differ depending on the state of the camera.

If you are unable to solve the problem even after trying the following corrective actions a few times, contact your Sony dealer or local authorized Sony service facility.

---

### C:32:□□

- There is trouble with your camera's hardware. Turn the power off and on again.

---

### C:13:□□

- The camera cannot read or write data on the recording medium. Re-insert the recording medium several times.
- An unformatted recording medium is inserted. Format the recording medium (pages 76, 78).
- The inserted recording medium cannot be used with your camera, or the data is damaged. Replace the recording medium (page 122, → *step 3 in "Read This First"*).

---

### E:61:□□

---

### E:91:□□

- A camera malfunction has occurred. Reset the camera (page 107), then turn the power on again.

## Messages

If the following messages appear, follow the instructions.



- The battery level is low. Charge the battery pack (→ *step 1 in "Read This First"*). Depending on the conditions of use or the type of battery pack, the indicator may flash even though there are still 5 to 10 minutes of remaining battery time left.

---

### For "InfoLITHIUM" battery only

- This battery pack is not a "InfoLITHIUM" type.

---

### System error

- Turn the power off and then on again (→ *step 2 in "Read This First"*).

---

### Insert Memory Stick Insert CF Card

- Insert the recording medium into the camera before connecting to a PictBridge compliant printer.
- Close the "Memory Stick"/CF card cover before making a PictBridge connection or during the connection.

---

### No Memory Stick

- Insert a "Memory Stick" (→ *step 3 in "Read This First"*).
- Set the /CF switch to CF and use a Microdrive/CF card.

---

### Reinsert the Memory Stick

- Insert the "Memory Stick" correctly.
- The inserted "Memory Stick" cannot be used in your camera (page 122).
- The "Memory Stick" is damaged.
- The terminal section of the "Memory Stick" is dirty.

---

### Memory Stick type error

- The inserted “Memory Stick” cannot be used in your camera (page 122).

---

### Format error

- Format the media again (pages 76 and 78).
- You are using the recording medium with the write-protect switch, and the switch is set to the LOCK position. Set the switch to the recording position (page 122).
- You cannot format the recording medium using the Memory Stick Duo Adaptor that is compliant with the CompactFlash slot.

---

### Memory Stick locked

- The write-protect switch of the “Memory Stick” is set to the LOCK position. Set the switch to the recording position (page 122).

---

### No memory space in Memory Stick

- Delete unnecessary images or files (→ *step 6 in “Read This First”*).



---

### Read only memory

- Your camera cannot record or delete images on this “Memory Stick”.

---

### No CF card

- Insert a Microdrive or CF card (→ *step 3 in “Read This First”*).
- Set the /CF switch to “” and use a “Memory Stick” (→ *step 3 in “Read This First”*).

---

### Reinsert the CF card

- Insert the Microdrive/CF card correctly.
- The inserted Microdrive/CF card cannot be used in your camera (page 124).
- The Microdrive/CF card is damaged.
- The terminal section of the Microdrive/CF card is dirty.

---

### CF card type error

- The inserted Microdrive/CF card cannot be used in your camera (page 124).

---

### CF card locked

- The Microdrive/CF card is set to be unrecordable. Refer to the operating instructions supplied with the medium.

---

### No memory space in CF card

- Delete unnecessary images or files (→ *step 6 in “Read This First”*).

---

### Close Cover

- Close the “Memory Stick”/CF card cover (→ *step 3 in “Read This First”*).
- Close the “Memory Stick”/CF card cover before or during the PictBridge connection (page 99).

---

### Cover open

- Close the “Memory Stick”/CF card cover (→ *step 3 in “Read This First”*).

---

### Open LCD Screen

- The LCD screen is closed when the FINDER/AUTO/LCD switch is set to LCD. Open the LCD screen or set the switch to FINDER (→ *step 5 in “Read This First”*).



---

### Read error

- The file is corrupted.

---

### Macro is invalid

- This appears when you select the macro mode with  (Twilight mode) or  (Landscape mode) selected in the Scene mode. In this case, the macro function is invalid.

---

### Manual focus is invalid

- When the mode dial is set to , set the FOCUS switch to MANUAL.

---

### FramingMode is invalid

- In the manual focus mode, even if you set to the FRAMING mode, the PREVIEW mode is activated instead.

---

### No file in this folder

- No images have been recorded in this folder.
- You did not operate correctly when copying images from your computer (page 92).

---

### Folder error

- A folder with the same first three digit number already exists on the recording medium (For example: 123MSDCF and 123ABCDE). Select other folders, or create a new folder (page 76).

---

### Cannot create more folders

- The folder with a name beginning with “999” exists on the recording medium. You cannot create any folders if this is the case.

---

### Cannot record

- The camera cannot record images in the selected folder. Select a different folder (page 77).

---

### File error

- An error occurred while playing back the image.

---

### File protect

- Release the protection (page 67).

---

### Image size over

- You are playing back an image of a size that cannot be played back on your camera.

---

### Invalid operation

- You are playing back a file that was created on equipment other than this camera.



### (Vibration warning indicator)

- Camera shake may occur due to insufficient light. Use the flash, mount the camera on a tripod, or otherwise secure the camera in place.

---

### Enable printer to connect

- [USB Connect] is set to [PictBridge], however the camera is connected to a non-PictBridge compliant device. Check the device.
- The connection is not established. Disconnect and connect the USB cable again. If an error message is indicated on the printer, refer to the operating instructions supplied with the printer.

---

### Connect to PictBridge device

- You tried to print images before the printer connection was established. Connect to a PictBridge compliant printer.



---

## No printable image

- You tried to execute [DPOF image] without placing a DPOF (Print order) mark on the image(s).
- You tried to execute [All In This Folder] while a folder that holds only RAW data files was selected. You cannot print RAW data files.

---

## Printer busy

### Paper error

### No Paper

### Ink error

### Low Ink

### No Ink

- Check the printer.

---

## Printer error

- Check the printer.
- Check if the image you want to print is corrupted.



- The data transmission to the printer may not be completed yet. Do not disconnect the USB cable.

---

## Processing

- The printer is canceling the current print job. You cannot print until it is finished. This may take time, depending on the printer.

# On the “Memory Stick”

A “Memory Stick” is a compact, portable IC recording medium. The types of “Memory Stick” that can be used with this camera are listed in the table below. However, proper operation cannot be guaranteed for all “Memory Stick” functions.

“Memory Stick” type	Recording/ Playback
Memory Stick (without MagicGate)	○
Memory Stick (with MagicGate)	○ <sup>2</sup> *3
Memory Stick Duo (without MagicGate) <sup>1</sup>	○
Memory Stick Duo (with MagicGate) <sup>1</sup>	○ <sup>2</sup> *3
MagicGate Memory Stick	○ <sup>2</sup>
MagicGate Memory Stick Duo <sup>1</sup>	○ <sup>2</sup>
Memory Stick PRO	○ <sup>2</sup> *3
Memory Stick PRO Duo <sup>1</sup>	○ <sup>2</sup> *3

<sup>1</sup> When using a “Memory Stick Duo” with this camera, be sure to insert it into a Memory Stick Duo Adaptor.

<sup>2</sup> These are equipped with MagicGate functions. MagicGate is copyright protection technology that uses encryption technology. Data recording/playback that requires MagicGate functions cannot be performed with this camera.

<sup>3</sup> Supports high-speed data transfer using a parallel interface.

- A “Memory Stick” formatted with a computer is not guaranteed to operate with this camera.
- Data read/write speeds differ depending on the combination of the “Memory Stick” and the equipment used.

## Notes on using a “Memory Stick” (not supplied)

- You cannot record, edit or delete images if you slide the write-protect switch to LOCK.

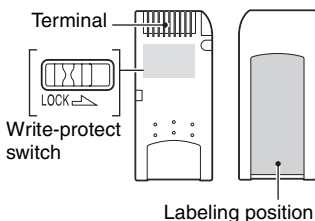

The position and/or the shape of the write-protect switch may differ depending on the “Memory Stick” you use.

- Do not remove the “Memory Stick” while reading or writing data.
- Data may be corrupted in the following cases:
  - When the “Memory Stick” is removed or the camera is turned off during a read or write operation
  - When the “Memory Stick” is used in locations subject to static electricity or electrical noise
- We recommend backing up important data.
- Do not attach any other material than the supplied label on the labeling position.
- When you attach the supplied label, be sure to attach it to the labeling position. Be careful that the label does not stick out.
- When you carry or store the “Memory Stick”, put it in the case supplied with it.
- Do not touch the terminal section of the “Memory Stick” with your hand or a metal object.
- Do not strike, bend or drop the “Memory Stick”.
- Do not disassemble or modify the “Memory Stick”.
- Do not expose the “Memory Stick” to water.
- Do not use or store the “Memory Stick” under the following conditions:
  - High temperature locations such as the hot interior of a car parked in direct sunlight
  - Locations exposed to direct sunlight
  - Humid locations or locations with corrosive substances present

## **Notes on using a “Memory Stick Duo” (not supplied)**

- To use a “Memory Stick Duo” with the camera, be sure to insert the “Memory Stick Duo” into a Memory Stick Duo Adaptor. If you insert a “Memory Stick Duo” into a “Memory Stick” compliant device without a Memory Stick Duo Adaptor, you might not be able to remove it from the device.
- When inserting a “Memory Stick Duo” into a Memory Stick Duo Adaptor, make sure the “Memory Stick Duo” is inserted facing in the correct direction.
- When using a “Memory Stick Duo” inserted into a Memory Stick Duo Adaptor with the camera, make sure that the “Memory Stick Duo” is inserted facing the correct direction. Note that improper use may damage the equipment.
- Do not insert a Memory Stick Duo Adaptor into a “Memory Stick” compliant device without a “Memory Stick Duo” attached. Doing so may result in malfunction of the unit.
- To format a “Memory Stick Duo”, insert the “Memory Stick Duo” into the Memory Stick Duo Adaptor.
- When the “Memory Stick Duo” is equipped with the write-protect switch, release its lock.

## **Note on using “Memory Stick PRO” (not supplied)**

“Memory Stick PRO” with a capacity up to 4 GB have been confirmed to operate properly with this camera.

# On the Microdrive

A Microdrive is a compact and lightweight hard disk drive that complies with CompactFlash Type II. Camera operations are confirmed using the following Microdrive

Hitachi Global Storage Technologies, Inc.

- DSCM-11000 (1 GB)
- 3K4-2 2GB (HMS 360402D5CF00)
- 3K4-4 4GB (HMS 360404D5CF00)
- 3K6-4 4GB (HMS 360604D5CF00)
- 3K6-6 6GB (HMS 360606D5CF00)

## Notes on use of the Microdrive

- Be sure to format the Microdrive using this camera when you use it for the first time.
- The Microdrive is a compact hard disk drive. Since the Microdrive is a rotating disk, the Microdrive is not strong enough to resist vibration and shock compared to a "Memory Stick," which uses flash memory.
- Be sure not to transmit vibration or shock to the Microdrive during playback or shooting.
- Data may be damaged in the following cases:
  - Removing the Microdrive while reading or writing data.
  - If you store the Microdrive near corrosive material.
- Note that the use of the Microdrive under 5°C (41°F) may bring performance degradation. Operating temperature range when using the Microdrive: 5° to 40°C (41°F to 104°F)
- Note that the Microdrive cannot be used under low atmospheric pressure (above 3 000 meters above sea-level).
- The Microdrive may be hot just after it has been used. Be careful when you handle it.
- Do not write on the label.
- Do not remove the label or attach a new label over the label.
- When you carry or store the Microdrive, put it in the case supplied with it.
- Do not expose the Microdrive to water.
- Do not press on the label strongly.
- Hold the sides of the Microdrive in your hand and do not squeeze the Microdrive.

# On the “InfoLITHIUM” battery pack

This camera requires an NP-FM50 battery pack.



## What is an “InfoLITHIUM” battery pack?

An “InfoLITHIUM” battery pack is a lithium-ion battery pack that has functions for exchanging information related to operating conditions with your camera. The “InfoLITHIUM” battery pack calculates the power consumption according to the operating conditions of your camera, and displays the remaining battery time in minutes.

## On charging the battery pack

We recommend charging the battery pack in an ambient temperature of between 10°C to 30°C (50°F to 86°F). You may not be able to efficiently charge the battery pack outside of this temperature range.

## Effective use of the battery pack

- Battery performance decreases in low temperature surroundings. So, the time that the battery pack can be used is shorter in cold places. We recommend the following to ensure longer battery pack use:
  - Put the battery pack in a pocket close to your body to warm it up, and insert it in your camera immediately before you start shooting.
- The battery pack will run out quickly if you use the flash or zoom frequently.
- We recommend having spare battery packs handy for two or three times the expected shooting time, and making trial shots before taking the actual shots.
- Do not expose the battery pack to water. The battery pack is not water-resistant.
- Do not leave the battery pack in extremely hot places, such as in a car or under direct sunlight.

## On the remaining battery time indicator

The power may go off although the battery remaining indicator shows there is enough power to operate. Use the battery pack up and charge the battery pack fully again so that the indication on the battery remaining indicator is correct. Note, however, that the correct battery indication sometimes will not be restored if the battery pack is used in high temperatures for a long time, left in a fully charged state or used frequently.

## How to store the battery pack

- If the battery pack is not to be used for a long time, fully charge it and then fully use it up once a year on your camera before storing the battery pack in a dry, cool place. Repeat this charging and using up once a year to maintain the battery pack's function.
- To use the battery pack up, leave your camera in slide show playback mode (page 67) until the power goes off.

## On battery life

- The battery life is limited. Battery capacity decreases little by little as you use it more and more, and as time passes. If the battery operating time seems shortened considerably, a probable cause is that the battery pack has reached the end of its life. Buy a new battery pack.
- The battery life varies according to how it is stored and the operating conditions and environment in which each battery pack is used.

# Precautions

## ■ Do not leave the camera in the following places

- In an extremely hot place

In places such as in a car parked in the sun, the camera body may become deformed and this may cause a malfunction.

- Under direct sunlight or near a heater

The camera body may become discolored or deformed, and this may cause a malfunction.

- In a location subject to rocking vibration
- Near strong magnetic place
- In sandy or dusty places

Be careful not to let sand or dust get into the camera. This may cause the camera to malfunction, and in some cases this malfunction cannot be repaired.

## ■ On carrying

- Close the LCD screen toward the body.
- Set the zoom fully to the W position to put the lens in.
- Attach the lens cap.

## ■ On cleaning

### Cleaning the LCD screen

Wipe the screen surface with an LCD cleaning kit (not supplied) to remove fingerprints, dust, etc.

### Cleaning the lens

Wipe the lens with a soft cloth to remove fingerprints, dust, etc.

### Cleaning the camera surface

Clean the camera surface with a soft cloth slightly moistened with water, then wipe the surface with a dry cloth. Do not use the following as they may damage the finish or the casing.

- Chemical products such as thinner, benzene, alcohol, disposable cloths, insect repellent, sunscreen or insecticide, etc.
- Do not touch the camera with the above on your hand.
- Do not leave the camera in contact with rubber or vinyl for a long time.

## ■ On operating temperatures

Your camera is designed for use under the temperatures between 0°C and 40°C (32°F and 104°F) (When using a Microdrive: 5°C and 40°C (41°F and 104°F)). Shooting in extremely cold or hot places that exceed this range is not recommended.

## ■ On moisture condensation

If the camera is brought directly from a cold to a warm location, moisture may condense inside or outside the camera. This moisture condensation may cause a malfunction of the camera.

### Moisture condensation occurs easily when:

- The camera is brought from a cold location such as a ski slope into a warmly heated room.
- The camera is taken from an air-conditioned room or car interior to the hot outdoors, etc.

### How to prevent moisture condensation

When bringing the camera from a cold place to a warm place, seal the camera in a plastic bag and allow it to adapt to conditions at the new location over about an hour.

### If moisture condensation occurs

Turn off the camera and wait about an hour for the moisture to evaporate. Note that if you attempt to shoot with moisture remaining inside the lens, you will be unable to record clear images.

## ■ On the internal rechargeable battery

This camera has an internal rechargeable battery for maintaining the date and time and other settings regardless of whether the power is on or off.

This rechargeable battery is continually charged as long as you are using the camera. However, if you use the camera for only short periods, it discharges gradually, and if you do not use the camera at all for about one month it becomes completely discharged. In this case, be sure to charge this rechargeable battery before using the camera.

However, even if this rechargeable battery is not charged, you can still use the camera as long as you do not record the date and time.

### **Charging method of the internal rechargeable battery**

Insert charged battery pack in the camera, or connect the camera to a wall outlet (wall socket) using the AC Adaptor, and leave the camera for 24 hours or more with the power off.

### **Charging method of the “InfoLITHIUM” battery pack**

→ *step 1 in “Read This First”*

# Specifications

## Camera

### [System]

Image device	21.5×14.4 mm color CMOS sensor, Primary 3-color filter
Total pixel number of camera	Approx. 10 784 000 pixels
Effective pixel number of camera	Approx. 10 286 000 pixels
Lens	Carl Zeiss Vario-Sonnar T* 5× zoom lens f = 14.3 – 71.5 mm (24 – 120 mm when converted to a 35 mm still camera) F2.8 – 4.8 Filter diameter: 67 mm
Exposure control	Automatic, Shutter speed priority, Aperture priority, Manual exposure, Scene selection (4 modes)
White balance	Automatic, Daylight, Cloudy, Fluorescent, Incandescent, Flash, One-push
File format (DCF compliant)	Still images: Exif Ver. 2.21 JPEG compliant, RAW (SR2), DPOF compatible
Recording media	“Memory Stick” Microdrive CompactFlash card (TypeI/TypeII)
Flash	Recommended distance (ISO set to Auto): approx. 0.5 m to 8.5 m (1 feet 7 3/4 inches to 27 feet 10 3/4 inches) (W)/approx. 0.4 m to 5.0 m (1 feet 3 3/4 inches to 16 feet 4 7/8 inches) (T)
Viewfinder	Electric viewfinder (color)

### [Input and Output connectors]

VIDEO OUT jack	Minijack 1 Vp-p, 75 Ω, unbalanced, sync negative
ACC jack	Mini-minijack (ø 2.5 mm)
USB jack	mini-B
USB communication	Hi-Speed USB (USB 2.0 compliant)

### [LCD screen]

LCD panel	5.1 cm (2.0 type) TFT drive
Total number of dots	134 000 (560×240) dots

### [Finder]

LCD panel	1.1 cm (0.44 type) TFT drive
Total number of dots	235 200 (980×240) dots

### [Power, general]

Used battery pack	Rechargeable battery pack NP-FM50
Power requirements	7.2 V
Power consumption (during shooting with LCD on)	1.7 W
Operating temperature	0°C to +40°C (+32°F to +104°F) (When using the Microdrive: +5°C to +40°C (41°F to +104°F))
Storage temperature	-20°C to +60°C (-4°F to +140°F)
Dimensions (lens: W-end)	139.4×97.7×156.0 mm (5 1/2×3 7/8×6 1/4 inches) (W/H/D, excluding protrusions)
Mass	Approx. 1047 g (2 lb 4.9 oz) (including NP-FM50 battery pack, “Memory Stick”, shoulder strap, and lens hood, etc.)
Speaker	Dynamic speaker
Exif Print	Compatible
PRINT Image Matching III	Compatible
PictBridge	Compatible



## AC-L15A AC Adaptor

Input rating	100 V to 240 V AC, 50/60 Hz, 18 W
Output rating	8.4 V DC* * See the label on the AC Adaptor for other specifications.
Operating temperature range	0°C to +40°C (32°F to +104°F)
Storage temperature range	-20°C to +60°C (-4°F to +140°F)
Maximum dimensions	Approx. 56 × 31 × 100 mm (2 1/4 × 1 1/4 × 4 inches) (W/H/ D), excluding projecting parts
Mass	Approx. 190 g (6.7 oz) excluding power cord (mains lead)













## Rechargeable battery pack NP-FM50

Used battery	Lithium-ion battery
Maximum voltage	DC 8.4 V
Nominal voltage	DC 7.2 V
Capacity	8.5 Wh (1 180 mAh)

Design and specifications are subject to change without notice.

# Quick reference chart for shooting



Available items differ depending on the position of the mode dial. The functions are restricted as follows.

Function \ Mode dial		P/S/A/M				
Focus mode						
Manual focus	—	○	○	○	○	○
Manual focus (PUSH AUTO)	—	○	○	○	○	○
Macro	○	○	—	○	—	○
AF	○	○	○	○	○	○
Monitor mode						
PREVIEW	○	○	○	○	○	○
FRAMING	○	○ (Invalid in manual focus mode.)				
AF range finder frame <sup>*1</sup>	—	○ <sup>*2</sup>				
Flash <sup>*3</sup>	○					○
White Balance	—	○ <sup>*4</sup>	○	AWB/ 	○ <sup>*4</sup>	○ <sup>*4</sup>
Metering mode	—	○	○	○	○	○
Burst/Exposure Bracket	○ <sup>*5</sup>	○	—	—	○	○
ISO sensitivity	—	○	—	—	—	—
AE LOCK button	—	○ (Invalid when selecting M mode)	○	○	○	○
 Self-timer	○	○	○	○	○	○
 (Digital zoom) button	○	○	○	○	○	○
 (Screen status) button	○	○	○	○	○	○

<sup>\*1</sup> When AF fill light is being emitted, AF operates with priority on subjects located near the center of the frame.





<sup>\*2</sup> This cannot be selected in digital zoom.  
When in Continuous AF, only  (Center AF) is available.  
This is invalid in manual focus mode.

<sup>\*3</sup> The flash is set to  (No flash) in Burst/Exposure Bracket mode.

<sup>\*4</sup> Except in [ WB] (Flash) or [] (One push) mode, white balance is set to [AWB] (Auto) when the flash strobes.

<sup>\*5</sup> The Exposure Bracket shooting cannot be used.

## Menu

Function \ Menu		P/S/A/M				
Image Size	○	○	○	○	○	○
P.Quality	—	○	○	○	○	○
REC Mode <sup>*1</sup>	○	○	○	○	○	○
Bracket Step <sup>*2</sup>	—	○	—	—	○	○
Flash Level <sup>*3</sup>	—	○	—	○	○	○
P.Effect	—	○	○	○	○	○
Color	—	○	—	—	—	—
Saturation	—	○	—	—	—	—
Contrast	—	○	—	—	—	—
Sharpness	—	○	—	—	—	—
Setup	○	○	○	○	○	○

\*1 RAW cannot be selected in Burst mode.

\*2 Only for BRK (Exposure Bracket mode)

\*3 This cannot be selected when the flash is set to  (No flash).

## A

- A.G.C.S. .... 64
- AC Adaptor
  - *step 1 in "Read This First"*
- Accessories supplied
  - *in "Read This First"*
- Adobe RGB ..... 57
- Advanced accessory shoe ..... 52
- AE LOCK ..... 43
- AE/AF lock indicator
  - *step 5 in "Read This First"*
- AF Illuminator ..... 73
- AF lock
  - *step 5 in "Read This First"*
- AF Mode ..... 47
- AF range finder frame ..... 46
- AF range finder frame indicator ..... 46
- Aperture ..... 12
- Aperture priority ..... 37
- Auto adjustment mode
  - *step 5 in "Read This First"*
- Auto Focus ..... 11
- Auto Review ..... 73

## B

- B&W ..... 63
- Battery pack
  - Battery life ..... 25
  - Charging
    - *step 1 in "Read This First"*
  - Install/Remove
    - *step 1 in "Read This First"*
  - Remaining indicator
    - *step 1 in "Read This First"*

- Beep ..... 80
  - *step 5 in "Read This First"*
- Blur ..... 11
- Bracket Step ..... 62
- BRK ..... 44

## C

- C AF ..... 48, 71
- Camera 1 ..... 71
- Camera 2 ..... 74
- CD-ROM ..... 85, 94, 96, 97
- Center AF ..... 46
- Center-weighted metering ..... 40
- CF Card Tool ..... 78
- Change REC. Folder ..... 77, 79
- Charging battery pack
  - *step 1 in "Read This First"*
- Cleaning ..... 126
- Clock Set ..... 82
- Cloudy ..... 55
- COLOR ..... 57
- Color ..... 13, 57
- Compression ratio ..... 14
- Computer ..... 83
  - Copying images ..... 85, 95
  - Macintosh ..... 95
  - Recommended environment ..... 84, 95
  - Software ..... 93
  - Viewing image files stored on a computer with your camera ..... 92
  - Windows ..... 83
- Connecting
  - Computer ..... 87
  - Printer ..... 100
  - TV ..... 105
- Continuous ..... 48
- Contrast ..... 64
- Conversion lens ..... 18

- Copying images to your computer ..... 85, 95
- Create REC. Folder ..... 76, 78

## D

- Date ..... 73
- Date/Time ..... 73
- Day&Time ..... 73
- Daylight ..... 55
- DC IN jack
  - *step 1 in "Read This First"*
- Delete
  - *step 6 in "Read This First"*
- Digital Zoom ..... 71
- DirectX ..... 84
- DPOF ..... 103

## E

- Effective pixels ..... 128
- Electronic transformer
  - *step 1 in "Read This First"*
- EV adjustment ..... 41
- EVF Backlight ..... 80
- Expanded Focus ..... 74
- Exposure ..... 12
- Exposure Bracket ..... 44
- Extension ..... 90, 92

## F

- File name ..... 90
- File Number ..... 81
- File storage destination ..... 90
- Fine ..... 62
- Flash ..... 55
- Flash Level ..... 63
- Flash mode
  - *step 5 in "Read This First"*
- Flash Synchro ..... 52

Flexible Spot AF.....	47
Fluorescent.....	55
F-number.....	37
Focus.....	11
Folder.....	65
Changing.....	77, 79
Creating.....	76, 78
Forced flash.....	50
Format.....	76, 78

## G

Grid Line.....	60
----------------	----

## H

Histogram.....	22, 41
Holding the camera → <i>step 5 in "Read This     First"</i>	

## I

Identifying parts.....	15
Image Data Converter SR .....	94, 97
Image file storage destinations and file names.....	90
Image quality.....	13, 62
Image size.....	13
→ <i>step 4 in "Read This     First"</i>	
ImageMixer VCD2.....	93, 96
Incandescent.....	55
Index mode printing.....	99
Index screen → <i>step 6 in "Read This     First"</i>	
Indicator.....	see "Screen"
"InfoLITHIUM" battery pack .....	125
Install.....	85, 93, 94, 96
Internal rechargeable battery .....	127
ISO.....	12

## J

JPG.....	91
----------	----

## L

Landscape mode.....	30
Language.....	80
→ <i>step 2 in "Read This     First"</i>	
LCD Backlight.....	80
LCD screen.....	see "Screen"
Lens adaptor.....	18
Lens hood.....	18

## M

M AF.....	48, 71
Macintosh computer.....	95
Recommended environment.....	95
Macro → <i>step 5 in "Read This     First"</i>	
Mains lead → <i>step 1 in "Read This     First"</i>	
Manual exposure.....	39
Manual focus.....	48
Mass Storage.....	81
"Memory Stick".....	122
Insert/Remove → <i>step 3 in "Read This     First"</i>	
Number of images.....	23
Write-protect switch ...	122
Memory Stick Tool.....	76
Menu.....	31
Shooting.....	62
Viewing.....	65
Metering mode.....	40
Mode.....	62
Moisture condensation.....	126
Monitor.....	48, 71
Monochrome.....	63

Multi-pattern metering.....	40
Multipoint AF.....	46

## N

NR slow shutter.....	37
NTSC.....	82
Number of images.....	23

## O

One push.....	55
One push SET.....	55
Optical zoom → <i>step 5 in "Read This     First"</i>	
OS.....	84, 95
Overexposure.....	12

## P

P.Effect.....	63
PAL.....	82
PC.....	see "Computer"
PFX.....	63
PictBridge.....	81, 99
Picture effect.....	63
PicturePackage.....	93
Pixel.....	13
Playback zoom → <i>step 6 in "Read This     First"</i>	
Pop-up Flash.....	51
Portrait mode.....	30
Power cord → <i>step 1 in "Read This     First"</i>	
Power Save.....	72
Precautions.....	126
Precision digital zoom.....	71
Pressing halfway down.....	11
→ <i>step 5 in "Read This     First"</i>	

Print .....	98	Setup .....	32, 64, 69	USB Connect .....	81
Index mode .....	99	Camera 1 .....	71	USB Driver .....	85
Single-image mode .....	99	Camera 2 .....	74	Using your camera abroad	
Print order mark .....	103	CF Card Tool .....	78	→ <i>step 1 in “Read This</i>	
Printing at a shop .....	103	Memory Stick Tool .....	76	<i>First”</i>	
Printing directly .....	99	Setup 1 .....	80	<b>V</b>	
Program auto shooting .....	29	Setup 2 .....	81	Video CD .....	93, 96
Program Shift .....	35	Setup 1 .....	80	Video Out .....	82
Protect .....	66	Setup 2 .....	81	Viewing	
PTP .....	81	Sharpness .....	64	Still image	
PUSH AUTO .....	48	Shooting		→ <i>step 6 in “Read This</i>	
<b>R</b>		Still image		<i>First”</i>	
RAW mode .....	59	→ <i>step 5 in “Read This</i>		Viewing menu .....	65
REC Mode .....	62	<i>First”</i>		Vivid .....	57
Red-eye reduction .....	51	Shooting menu .....	62	<b>W</b>	
Reducing flicker .....	61	Shoulder strap .....	18	Warning indicators and	
RESET .....	107	Shutter speed .....	12	messages .....	118
Resize .....	68	Shutter speed priority .....	36	White Balance .....	55
Rotate .....	69	Single .....	48, 71	Windows computer .....	83
<b>S</b>		Single-image mode printing		Recommended	
S AF .....	48, 71	.....	99	environment .....	84
Saturation .....	63	Slide .....	67	Write-protect switch .....	122
Scene Selection .....	30	Slow synchro .....	50	<b>Z</b>	
Screen		Smart zoom .....	71	Zebra .....	42
Changing the display .....	22	Software .....	93	Zoom	
Indicator .....	19	Specifications .....	128	→ <i>step 5 in “Read This</i>	
LCD Backlight .....	80	Spot metering .....	40	<i>First”</i>	
Self-diagnosis display .....	118	Spot metering cross hairs .....	40		
Self-timer		Standard .....	62		
→ <i>step 5 in “Read This</i>		STD .....	62		
<i>First”</i>		<b>T</b>			
Sepia .....	63	Trimming .....	70		
Set the clock		Troubleshooting .....	107		
→ <i>step 2 in “Read This</i>		TV .....	105		
<i>First”</i>		Twilight mode .....	30		
		Twilight portrait mode .....	30		
		<b>U</b>			
		Underexposure .....	12		
		USB cable .....	87, 100		

## Trademarks

- **Cyber-shot** is a trademark of Sony Corporation.
- “Memory Stick”  “Memory Stick PRO”, **MEMORY STICK PRO**, “Memory Stick Duo”, **MEMORY STICK DUO**, “Memory Stick PRO Duo”, **MEMORY STICK PRO DUO**, “MagicGate”, and **MAGICGATE** are trademarks of Sony Corporation.
- “InfoLITHIUM” is a trademark of Sony Corporation.
- PicturePackage is a trademark of Sony Corporation.
- Microsoft, Windows, Windows Media, and DirectX are either registered trademarks or trademarks of Microsoft Corporation in the United States and/or other countries.
- Macintosh, Mac OS, QuickTime, iMac, iBook, PowerBook, Power Mac, and eMac are trademarks or registered trademarks of Apple Computer, Inc.
- Macromedia and Flash are trademarks or registered trademarks of Macromedia, Inc. in the United States and/or other countries.
- Intel, MMX, and Pentium are trademarks or registered trademarks of Intel Corporation.
- CompactFlash is a trademark of SanDisk Corporation.
- Microdrive is a registered trademark of Hitachi Global Storage Technologies in the United States and/or other countries.
- Adobe is a registered trademark or a trademark of Adobe Systems Incorporated in the United States and/or other countries.
- In addition, system and product names used in this manual are, in general, trademarks or registered trademarks of their respective developers or manufacturers. However, the <sup>TM</sup> or © marks are not used in all cases in this manual.